

Thermohydraulic performance of Curved Delta Winglet Vortex Generator using Ramped Expansion Channel

Devaprasath A¹, Gowtham S¹, Hariharan V¹, Sivakumar S²

¹Student, Department of Mechanical Engineering, Kumaraguru College of Technology, Tamil Nadu, India.

²Assistant Professor II, Department of Mechanical Engineering, Kumaraguru College of Technology, Tamil Nadu, India.

Abstract – The search for improving heat transfer and fluid mixing efficiency in diverse engineering applications has prompted the investigation of novel vortex generator geometries and combinations. This study examines the thermohydraulic performance of a new ramping expansion channel incorporated curved delta winglet vortex generator. The goal of the curved delta winglet vortex generator is to minimize pressure loss while increasing convective heat transfer and creating vortices. The use of a ramped expansion channel is intended to regulate the flow field and enhance the capacity for heat transmission. The study methodically investigates the effects of ramp angle, winglet height, and geometrical factors on the system's thermohydraulic performance.

Key Words: Heat transfer, vortex generator, ramped expansion channel, ramp angle.

1. INTRODUCTION

The utilization of vortex generators in real-time has been made possible by recent successful inventions, research, and testing aimed at improving the effect of heat transmission. By creating vortices in the boundary layer, delta winglet vortex generators have traditionally shown themselves to be effective in enhancing convective heat transfer. But more recently, developments have accelerated the shift to curved versions, leveraging the advantages of curved geometries to maximize vorticity production and flow management. Meanwhile, the addition of a ramped expansion channel gives the flow route a new dimension and improves mixing and heat transmission properties. Comprehending the complexities of heat transmission and fluid movement in this unique arrangement is crucial for improving thermal engineering techniques. The knowledge gained from this study may be applied to the design and improvement of air-cooling systems, heat exchangers, and other thermal management equipment, leading to the creation of more sustainable and energy-efficient engineering solutions.

1.1 Ramped expansion channel

Separated flows are difficult to understand because of their unpredictable nature. To better understand these

instabilities and, to some extent, reduce the unpredictability, researchers have been experimenting with a variety of shapes, including rib, fence, bluff body with a splitter plate, abruptly expanding pipes, ramping duct, and cavities. Because of its one set separation point, the ramped expansion channel proved to be the most popular of all. There are three main areas that make up the flow wake: the shear layer area, the separation bubble or recirculation zone, and the reattachment zone. These divisions are based on the important flow characteristics in a planar ramping geometry that have been studied by previous researchers. Due to the unfavorable pressure gradient that forms into a thin boundary layer, the basic features of a ramped expansion flow start with an angular momentum in the flow. The turbulent structures inside the boundary layer merge as the flow moves downstream, expanding the boundary layer's area. The term "layer region" refers to this area where the boundary layer forms and expands. In the space between the shear layer and the nearby wall, this flow results in low-velocity recirculation. The recirculation zone of the ramping geometry produces a primary vortex in the center and a secondary vortex adjacent to the corner. When the shear layer eventually swings down towards the wall, the reattachment point is where the fluid's advantageous pressure gradient hits the wall at a specific location.

1.2 Vortex Generator

To provide a safety buffer between the airspeed and stall speed, vortex generators are tools that help lower the stall speed. By increasing the flow's turbulent nature and decreasing the creation of boundary layers, vortex generators aid in improving heat transfer performance. In a channel, the strong turbulent flow of the medium decreases the development of boundary layers and increases heat transmission. Based on their features and usage patterns, vortex generators may be categorized. Both passive and active vortex generators are those. Using a certain aerodynamic surface shape, passive vortex generators may produce rolling or longitudinal vertices without the need for outside power sources. Delta winglet (DW) and Delta winglet pair (DWP) are the most utilized configurations. A winglet is created when the vortex generators have distinct angles of attack from one another, whereas a wing is defined as geometry positioned perpendicular to the direction of flow.

2. Methodology

Scientifically sound discoveries are produced by study using a sound approach. The procedure is made easy, efficient, and manageable by the comprehensive strategy it offers, which also aids in keeping researchers on course. Finding trustworthy and accurate data, coming to insightful conclusions, and adding to the body of knowledge are all hampered by a poorly defined research technique.

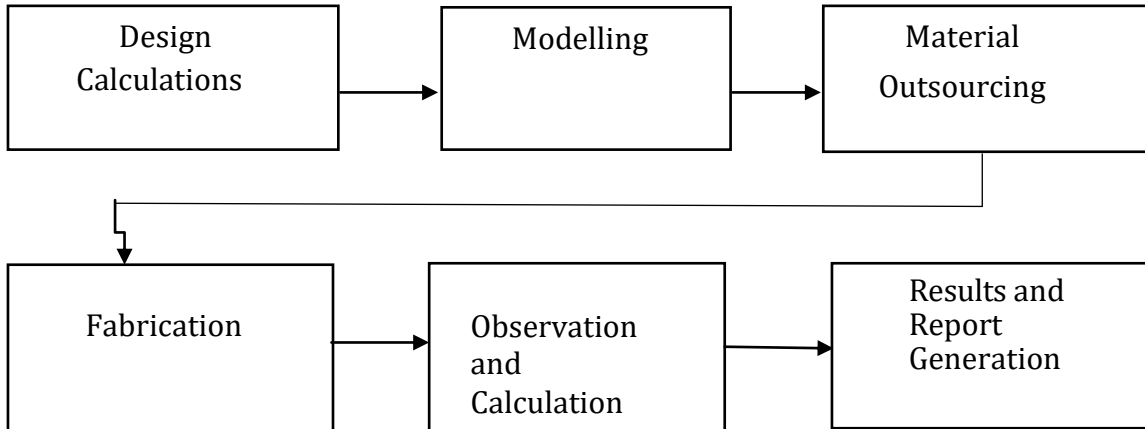

Fig. 1. Methodology Flowchart

3. Design Calculation

Setting up an experiment is a crucial step in carrying out a study. The experiment involves designing the vortex generators and the sudden expansion ramping flow duct by consulting references from different journals and modifying their specifications according to the needs. The final output varies depending on the stability, capacity, performance, and durability of the materials utilized in the process.

3.1. Ramped Expansion channel dimensions

- **Comic Section**

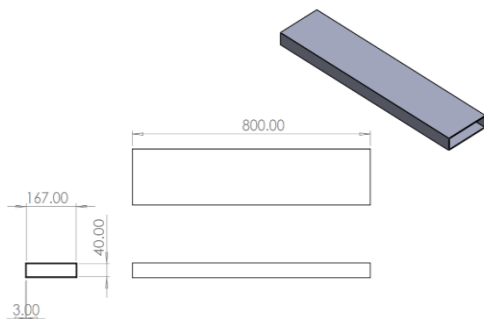

All dimensions are in mm.

Fig. 2. Comic Section

- **Testing Section**

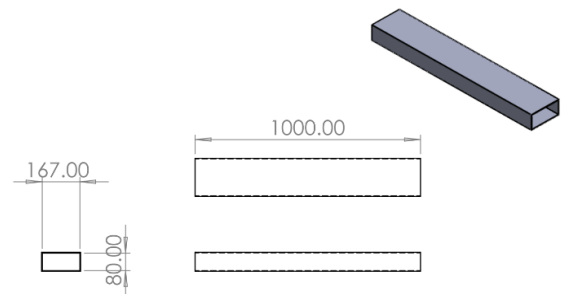

All dimensions are in mm.

Fig. 3. Testing Section

- **Ramped duct angle = 45°**



Fig. 4. Ramped expansion channel

3.2. Delta Vortex Generator Dimensions

- Height = 27 mm
- Length = 45 mm
- Radius = 23 mm
- Thickness = 1mm
- Material = Curable Alumina

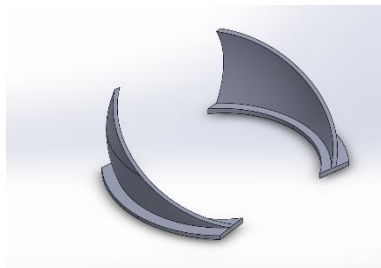

Fig.5. Curved Delta Vortex Generator

4. Component Specification

S.No.	MATERIALS	DIMENSION
1	Copper Plate	1000 x 167 x 2.5 mm
4	Plexiglass(acrylic) Sheet	1800 × 167 × 3 mm
5	Thermocouple (T-type)	∅ = 0.2mm (Accuracy = 0.02°C)
6	Nylon	1 kg
7	Rock Wool	2 sq. m.
8	Blower	200 Cubic Feet Per Minute
9	Heater (stainless steel)	1000mm × 200mm
10	Variac Controller	0-240 V (single phase)
11	Data Acquisition System	18 channels
12	Thermometer	Accuracy = ±0.02°C

Table.1. Component Specification

5. Experimental Setup

The rock-wool insulation bed is positioned at the bottom of the test section, with the heater employed in between the copper plates. We utilize an air blower on the other side of the entrance to change the direction of the air flow. Variac controllers are used to regulate both the heater and the blower's voltage input. Plexi sheet is used to construct the test and comic sections, which are joined to form a channel that is enclosed on all sides except the input and outflow. We employ 18 "T-type" thermocouples, which are affixed to the copper plate's bottom in a direction parallel to the stream to

measure the temperature of the plate. A data acquisition system (DAQ) is then used to measure the readings from these thermocouples and display the corresponding outputs. The mass flow rate of air at the comic section's input is measured with a vane anemometer. Pressure transducers are used at the channel's entrance and outflow to measure the pressure decrease.

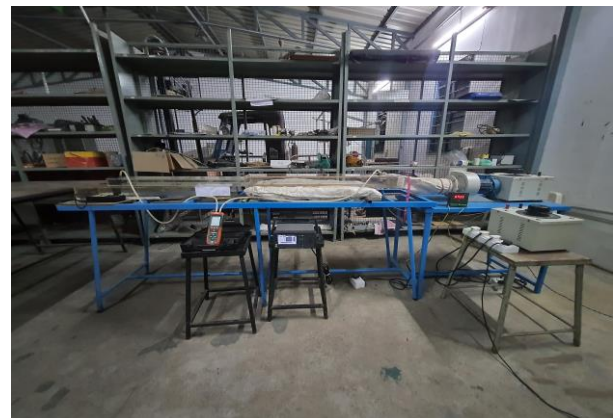

Fig.6. Experimental Setup

6. Experimentation and Observation

In this experimentation, we position the Curved Delta Vortex Generator with higher leading edge in both common flow up and common flow down configuration and observe their heat transmission capabilities by varying the velocity of the fluid for different attack angle of the vortex generator.

- **Common Flow Up (CFU) configuration of Curved Delta Vortex Generator - [All angle comparison]**

$$\text{Friction Factor, } f = (2 \cdot \Delta P \cdot D_h) / (\rho \cdot V^2 \cdot L)$$

$$\text{Reynolds Number, } Re = (\rho \cdot V \cdot D_h) / \mu$$

The relation shows that the friction factor decreases as the velocity of the fluid increases and the Reynolds number increases as the velocity of the fluid increases.

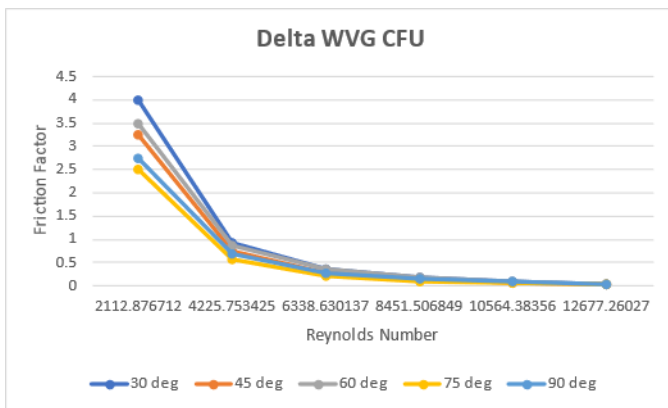

Fig.7. Friction factor vs Reynolds number

Nusselt number, $Nu = (h \cdot D_h) / k$

Reynolds Number, $Re = (\rho \cdot V \cdot D_h) / \mu$

The Nusselt number is the function of Reynolds number raised to the certain power along with the Prandtl number.

Laminar External flow, $Nu \approx 0.664 \cdot (Re^{0.5}) \cdot (Pr^{0.33})$

Turbulent External flow, $Nu \approx 0.037 \cdot (Re^{0.8}) \cdot (Pr^{0.3})$

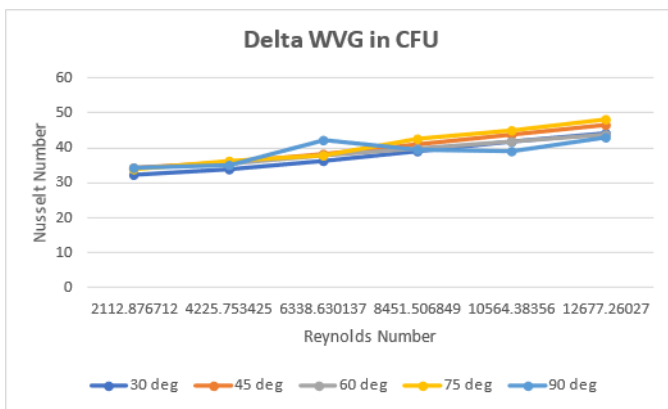

Fig.8. Nusselt number vs Reynolds number

The above graph (Fig.8.) indicates the relation between Nusselt number and Reynolds number for various attack angles.

Both the above graphs, (Fig.7.) and (Fig.8.) implies that the attack angle 75° shows the better thermohydraulic performance factor with greater heat transmission rate and lower pressure loss compared to all other attack angles being positioned in the common flow up configuration.

Attack Angle = 75°			
Velocity	Friction factor	Nusselt number	Reynolds number
0.5	3.752198554	34.2231459	1.150552063
1.0	0.812976353	36.37359485	1.197363096
1.5	0.33352876	39.1194846	1.206706762
2.0	0.171975767	41.36928989	1.315630464
2.5	0.100058628	43.72431723	1.370783653
3.0	0.055588127	47.19983024	1.199323008

Table.2. Data obtained for Attack angle 75° in CFU

- **Common Flow Down (CFD) configuration of Curved Delta Vortex Generator - [All angle comparison]**

Analyzing the common flow down performance of the Curved Delta Vortex Generator in the ramped expansion channel resulted in the following outcomes.

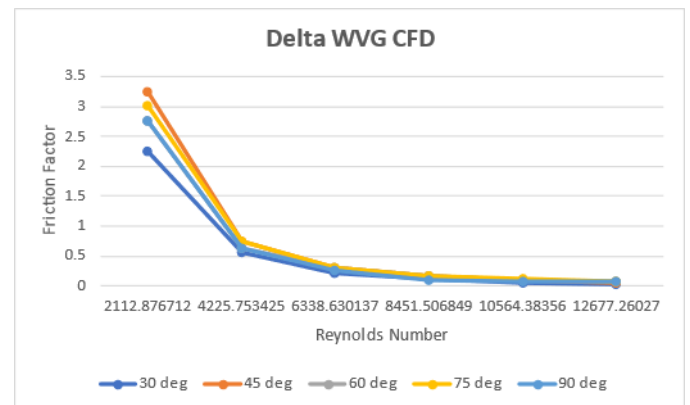

Fig.9. Friction factor vs Reynolds number

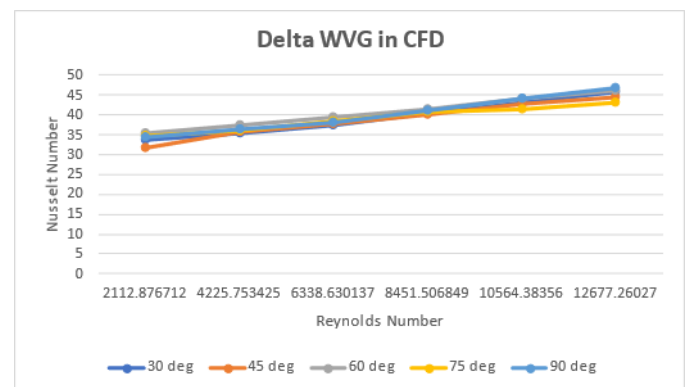

Fig.10. Nusselt number vs Reynolds number

Both the above graphs, (Fig.9.) and (Fig.10.) implies that the attack angle 30° shows the better thermohydraulic performance factor with greater heat transmission rate and lower pressure loss compared to all other attack angles being positioned in the common flow down configuration.

Attack Angle = 30°			
Velocity	Friction factor	Nusselt number	Reynolds number
0.5	3.251905413	34.81170847	1.180900767
1.0	0.750439711	35.66782946	1.168086722
1.5	0.305734697	37.90375476	1.194761261
2.0	0.171975767	39.90780703	1.117782941
2.5	0.090052765	41.7500661	1.232384665
3.0	0.048639611	46.1448099	1.140085539

Table.3. Data obtained for Attack angle 30° in CFD

7. CONCLUSIONS

Hydro-thermal characteristics of the ramped expansion channel in under process. Further the channel with a curved delta winglet vortex generator is made using Curable Alumina filament and placed in the channel. Both Common flow up and Common flow down configurations with varying angles of attacks are experimented with. The overall performance of the vortex generator is evaluated with Nu number and Friction factor. The below listed configuration shows the greater performance characteristics in the ramped expansion channel using Curved Delta Vortex Generator.

Configuration	Attack Angle	Thermo hydraulic performance factor
CFU	75°	1.2401
CFD	30°	1.3554

Table.4. End result of the above experimental study

ACKNOWLEDGEMENT

We wholeheartedly thank our Chairman **Dr. B. K Krishnaraj Vanavarayar**, our Correspondent **Thiru. M.Balasubramaniam**, our Joint Correspondent **Thiru. Shankar Vanavarayar**, our advisor **Dr. V. Manivel muralidaran** for providing us with the required infrastructure at Kumaraguru College of Technology. We express our gratitude to our beloved Principal **Dr. D. Saravanan**, for his invaluable support, motivation, and

guidance, and also for providing us all the necessary facilities required for carrying out this project work. We are very grateful to our respected Head of the Department, Mechanical Engineering, **Dr. C. Velmurugan** for his constant and continuous motivation, review, and cooperation throughout this project work. We wish to record our profound happiness and gratitude to our Project Coordinator **Dr. K. M. Senthilkumar**, **DR. K. Krishnamoorthi**, **DR. S. Sivakumar** and Project Guide **Mr. S. Sivakumar** for their constant and continuous effort, guidance, and valuable time. Our sincere and hearty thanks to all the faculty members and staff of Mechanical Engineering Department for their well wishes, timely help and support rendered to us for doing this final year design and fabrication project work. We are very greatly indebted to our family, relatives and our all friends without whom our life would not have been shaped to this level.

REFERENCES

- [1] Esmaeilzadeh, N. Amanifard, and H. M. Deylami, "In order to maximize flow characteristics and enhance heat transfer in a heat exchanger, a comparison of straight and curved trapezoidal longitudinal vortex generators was conducted," *Appl. Therm. Eng.*, vol. 125, pp. 1414–1425, 2017.
- [2] Armaly, B., Durst, F., Pereira, J., & Schönung, B. Experimental and theoretical investigation of backward-facing step flow. *Journal of Fluid Mechanics*, 127, 473-496. doi:10.1017/S0022112083002839
- [3] W. Hu, L. Wang, Y. Guan, and W. Hu, "The impact of winglet vortex generator shape on a circular tube bank fin heat exchanger's thermal-hydrodynamic performance," *Heat Mass Transf. und Stoffuebertragung*, vol. 53, no. 9, pp. 2961–2973, 2017.
- [4] M. F. Md Salleh, H. A. Mohammed, and M. A. Wahid, "Thermal and hydraulic characteristics of trapezoidal winglet across fin-and-tube heat exchanger (FTHE)," *Appl. Therm. Eng.*, vol. 149, no. November 2018, pp. 1379–1393, 2019.
- [5] S. K. Sarangi, D. P. Mishra, H. Ramachandran, N. Anand, V. Masih, and L. S. Brar, "Examining and refining the small heat exchanger's curved trapezoidal winglet geometry," *Appl. Therm. Eng.*, vol. 182, no. September 2020, p. 116088, 2021.
- [6] J. Carpio and A. Valencia, "Enhancement of heat transfer using longitudinal vortex generators in flat-tube compact heat exchangers," *Int. Commun. Heat Mass Transf.*, vol. 120, no. xxxx, p. 105035, 2021.

- [7] Tsay, YL., Chang, T. & Cheng, J. Enhancement of heat transfer for backward-facing step flow in a channel with the placement of baffles on the channel wall. *Acta Mechanica* 174, 63–76 (2005). <https://doi.org/10.1007/s00707-004-0147-5>
- [8] Abbott, D. E., and Kline, S. J. (September 1, 1962). "Examining Subsonic Turbulent Flow Through Single and Double Backward Facing Steps Experimentally." *ASME. J. Basic Eng.* September 1962; 84(3): 317–325. <https://doi.org/10.1115/1.3657313>
- [9] Kanna, P. R., and Das, M. K. (January 25, 2006). "A two-dimensional Laminar Inflexible Wall Jet Flow Under Backward-Facing Step: A Numerical Simulation." *ASME. J. Fluids Eng.* September 2006; 128(5): 1023–1035. <https://doi.org/10.1115/1.2243298>