

Analysis of Stiffened Plates using FEM – A Parametric Study

Deepak Kumar Singh¹, S K Duggal², P Pal³

¹Research Scholar, Civil Engineering Department, MNNIT Allahabad, U.P., India

²Professor, Civil Engineering Department, MNNIT Allahabad, U.P., India

³Assistant Professor, Civil Engineering Department, MNNIT Allahabad, U.P., India

Abstract - This paper deals with the behavior of stiffened plates subjected to different loading conditions. Finite element method is used for modelling and analysis of the stiffened plates. The maximum deflection at the center of bare plate is verified with the reported results. A parametric study is carried out to estimate the maximum deflection and stress in the isotropic plates by varying the geometry of stiffener keeping the constant volume of material.

Key Words: Thin plate, Stiffener, Finite element method, ANSYS workbench 15.

1. INTRODUCTION

A plate is a flat structural element in which the thickness is very small compared to the surface dimensions. A plate is characterised based on its thickness as very thin if width to thickness ratio is greater than 100, moderately thin if ratio fall between 20 to 100, thick if fall between 3 to 20 and very thick if less than 3^[1].

Of the available plate theories, following two are widely accepted and used^[2],

- The Kirchhoff–Love theory of plates (classical plate theory)
- The Mindlin–Reissner theory of plates (first-order shear plate theory)

Although thick-plate formulation is recommended in general because it tends to be more accurate. For thin-plate bending problems in which shear deformation is truly negligible, the use of thick plate formulation is in practice because of its easy application. However, the accuracy of thick-plate formulation is sensitive to mesh distortion and large aspect ratios, and therefore should not be used in such cases when shear deformation is known to be small.

The economical design of plate can be obtained by using stiffeners instead of increasing the thickness of plate. Stiffeners are secondary plates or sections used to stiffen the primary element or member. Stiffened plates are widely used in different fields of engineering viz. ships, aircrafts, airframes, chemical industry structures etc. The stiffened plates are needed to avoid the use of thick plates that produce high weight for the structures. Stiffened plates are light weight, high-strength structural elements^[3]. The stiffeners enhance the rigidity of base structures by increasing their cross sectional moment of

inertia^[4]. The configuration of the stiffeners should be consistent with the natural modes likely to be excited by the service loads, so as to arrive at a design with a high strength-to-weight ratio^[5].

The optimum locations of the ribs or stiffeners for a given set of design constraints were studied by Hasan^[6]. The authors found the best design of stiffened plates when stiffeners were used on either side of square plate. The stiffened clamped plate subjected to a pressure was studied by Yousif et al.^[3]. The investigation carried out to find out the optimum height which was found to be in between 40 and 50mm. The relationship between the deflections of a clamped plate subjected to pressure was studied by Pedatzur^[7]. The stiffened plates for various types of loadings and stiffeners shape were investigated by Virag^[8]. Author concluded that the trapezoidal stiffener is the most economic one. The cost saving can be 69% when compared with various ribs. Paykani et. al.^[9] investigated the bending of an isotropic rectangular plate for various boundary conditions using MATLAB code and ANSYS. Classical plate theory (CPT) and plane stress assumption were used.

2. THEORETICAL FORMULATION

The Kirchhoff-Love and Reissner-Mindlin FSDT are well known in literature. The descriptions for these formulations are circumvented here in for the sake of conciseness of this paper. Only the Finite element modeling is presented in the next section, for completeness of the paper and convenience of the reader.

3. FINITE ELEMENT MODELLING

Finite element modeling consists of four steps: creating the geometry of the model, generating a mesh for the solid mesh (i.e. dividing the model into elements), applying boundary conditions and loadings, and final is solution. A number of finite element based computer programs (NASTRAN, PATRAN, MARC, CATIA, ANSYS etc.) may be used for the analysis of stiffened plates. ANSYS Workbench 15 is used in the present investigation.

A square plate of size 1000×1000×10mm, shown in Fig-1(a), is consider in the present study and the different dimensions of stiffeners are used to attach with the plate by keeping the constant volume of material (10320000 mm³) throughout which is presented in Table-2. Although a many shapes of stiffeners may be used to strengthen the plates to increase the stiffness of the structures like flat, L-

shape, trapezoidal or other shapes^[8] however, a flat plate stiffener is used in the present study which is shown in Fig-1(b).

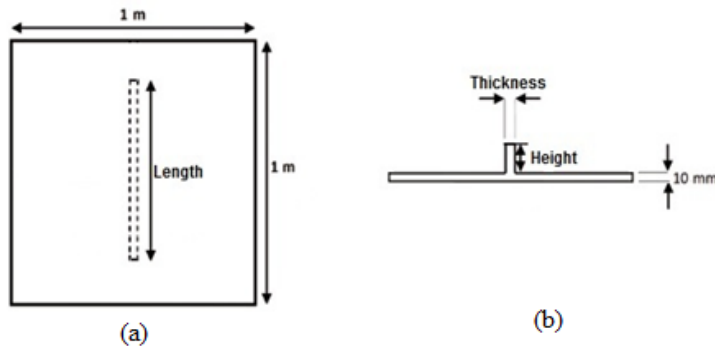

Fig-1: Geometry of stiffened plate

At first a convergence study is carried out to decide the mesh size for modelling the bare plate. The investigation is carried out for the maximum deflection value at the center of the plate. The obtained results are shown in Fig-2. It is observed that the results are coming very close when the mesh size is 20×20. So, the mesh of 20×20 is adopted for modelling the plate in other problems which are presented below.

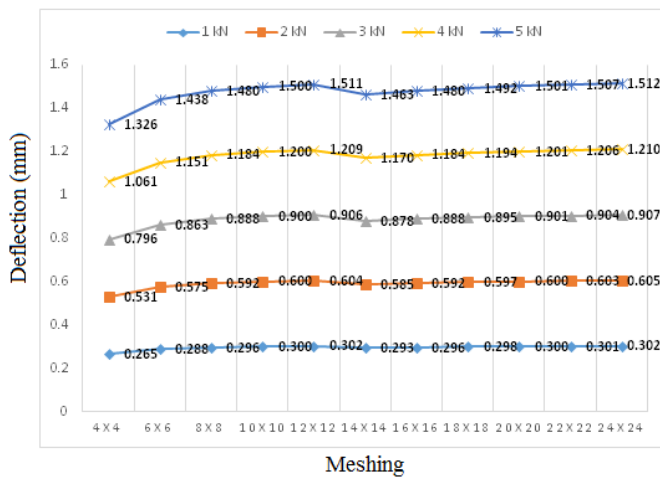

Fig-2: Convergence study

SOLID73 element is used for modelling the square plate and BEAM3 element is used for modelling the stiffener which is shown in Fig-3. The SOLID73 element is defined by eight nodes having six degrees of freedom at each node: translations in x, y, and z directions and rotations about x, y, and z axes. BEAM3 element is a uniaxial element with tension, compression, and bending capabilities which is used as stiffener. The element has three degrees of freedom at each node: translations in x and y directions and rotation about z-axis.

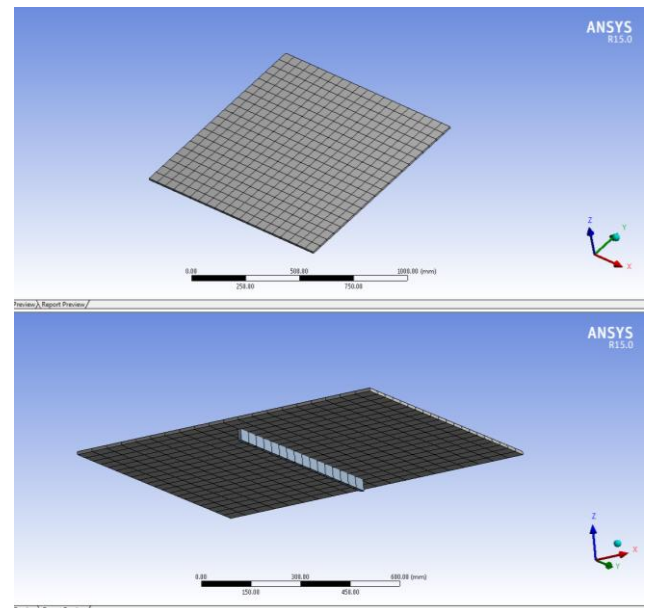

Fig-3: Meshing of stiffened plate

4. RESULTS AND DISCUSSIONS

Different examples are studied in the present study. In example 1, a bare plate is analysed for point and uniformly distributed load for fixed and simply supported edges boundary conditions. In example 2, a parametric study is carried out for different combinations of stiffener plate geometry. In example 3, a parametric study is carried out further for 5 kN and 5 kN/m² loads for fixed and simply supported edges boundary conditions with different combinations of stiffener plate geometry. In example 4, a bare plate is analysed to estimate the deflection and the corresponding stress. In example 5, maximum deflection and the corresponding stress are calculated for stiffened plates.

4.1 Example-1: A bare square plate of size 1000×1000×10 mm is analysed first to determine the maximum deflection at the center of the plate for different loading and boundary conditions. The obtained results are presented in Table-1 and compared with the reported results published by Timoshenko & Krieger^[10]. The maximum deflection and stress for point (1 kN) or uniformly distributed load (1 kN/m²) for both boundary conditions are shown in Fig-4.

Table-1: Validation of results for bare plate

S. No.	Boundary and loading conditions	Deflection (mm) obtained by ANSYS	Deflection (mm) calculated by formula given by Timoshenko [10]	Percentage error (%)
1.	All edges fixed with uniformly distributed load (1 kN/m ²)	0.0691	0.0688	0.4288
2.	All edges fixed with point load (1 kN)	0.3440	0.3712	7.3529
3.	All edges simply supported with uniformly distributed load (1 kN/m ²)	0.2222	0.2279	2.5230
4.	All edges simply supported with point load (1 kN)	0.6346	0.6334	0.1862

4.2 Example-2: In this example, a parametric study is carried out for different combinations of stiffener plate geometry which is given in Table-2. The models are analysed for varying point load (1 kN, 2 kN, 3 kN, 4 kN and 5 kN) and uniformly distributed load (1 kN/m², 2 kN/m², 3 kN/m², 4 kN/m² and 5 kN/m²) for simply supported and fixed edges boundary conditions.

Table-2: Dimension of stiffener plate keeping thickness, height and length constant

S. No.	Thickness (mm)	Length (mm)	Height (mm)
Case-I: Dimension of stiffener plate keeping thickness constant, varying height by 5mm			
1.	10	800.0000	40
2.	10	711.1100	45
3.	10	640.0000	50
4.	10	581.8190	55
5.	10	533.3300	60
Case-II: Dimension of stiffener plate keeping thickness constant, varying length by 50mm			
6.	10	750	42.6700
7.	10	700	45.7143
8.	10	650	49.2310
9.	10	600	53.3300
10.	10	550	58.1818
Case-III: Dimension of stiffener plate keeping length constant, varying thickness by 2mm			
11.	12	650	41.0256
12.	14	650	35.1648
13.	16	650	30.7692
14.	18	650	27.3504
15.	20	650	24.6154
Case-IV: Dimension of stiffener plate keeping length constant, varying height by 5mm			
16.	08.2051	650	60
17.	08.9510	650	55
18.	09.8461	650	50
19.	10.9400	650	45
20.	12.3077	650	40
Case-V: Dimension of stiffener plate keeping height constant, varying thickness by 2mm			
21.	12	666.6700	40
22.	14	571.4286	40
23.	16	500.0000	40
24.	18	444.4400	40
25.	20	400.0000	40
Case-VI: Dimension of stiffener plate keeping height constant, varying length by 50mm			
26.	10.6700	750	40
27.	11.4286	700	40
28.	12.3077	650	40
29.	13.3300	600	40
30.	14.5400	550	40

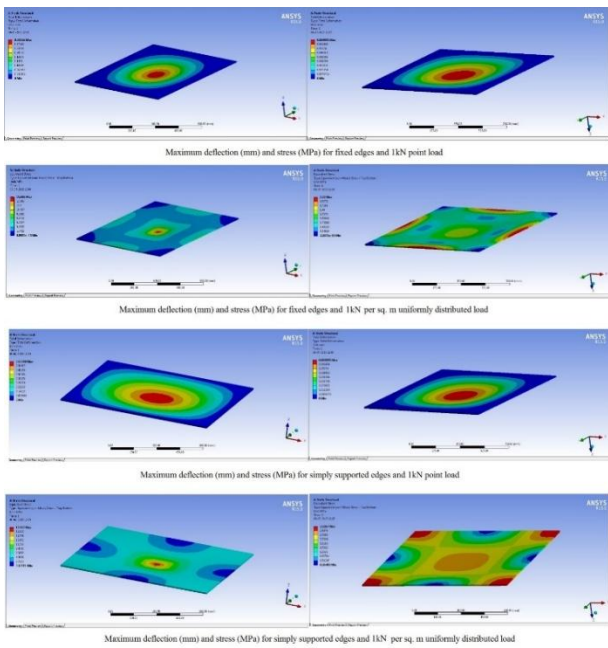

Fig-4: Maximum deflection and stress for point (1 kN) or uniformly distributed load (1 kN/m²) for both boundary conditions

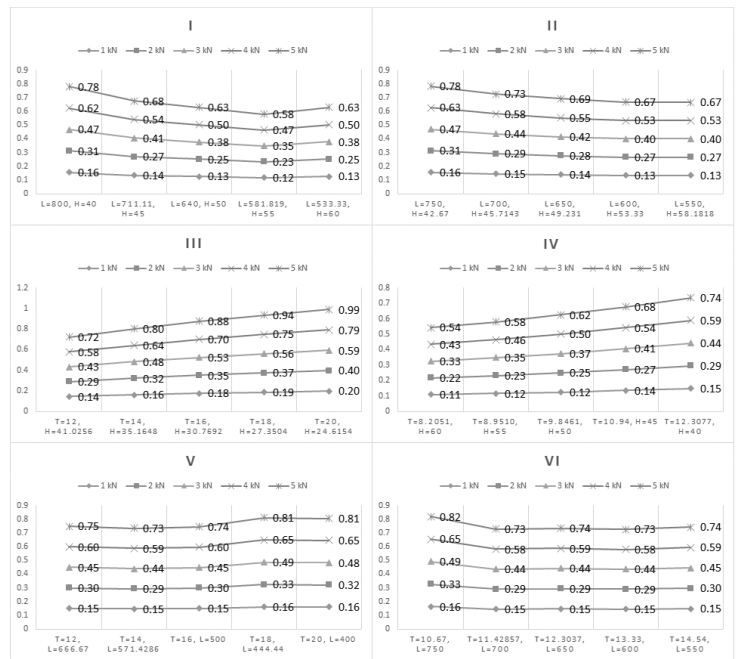

Fig-5: Maximum deflection for point load and fixed edges condition

Figures 5, 6, 7 and 8 show the maximum deflection at the center of the stiffened plate for different loading and boundary conditions by varying the different combinations of stiffener geometry. It is observed that the maximum deflection of plate for 1 kN and 1 kN/m² load is almost same in all the cases. The deflection value is increased with the increase of load. However, the variation of deflection is quite large for all the cases when the load is 5 kN and 5 kN/m². The variation is observed to be quite large in IIIrd case, shown in figures 5, 6 and 7, when the length of the stiffener is remain constant and the height of stiffener is decreased and the thickness of stiffener is increased. However, the large variation is observed in Vth case for simply supported edges and uniformly distributed load which is shown in Fig-8.

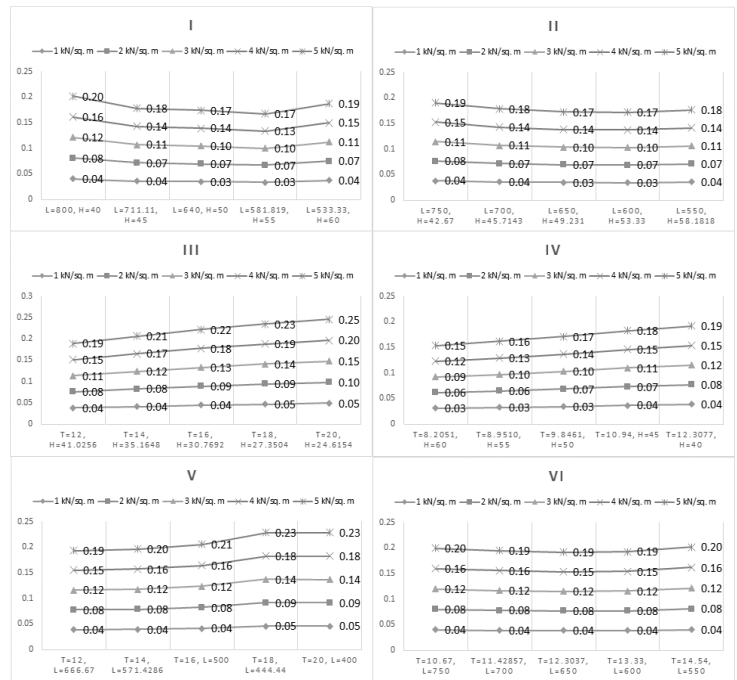

Fig-6: Maximum deflection for uniformly distributed load and fixed edges condition

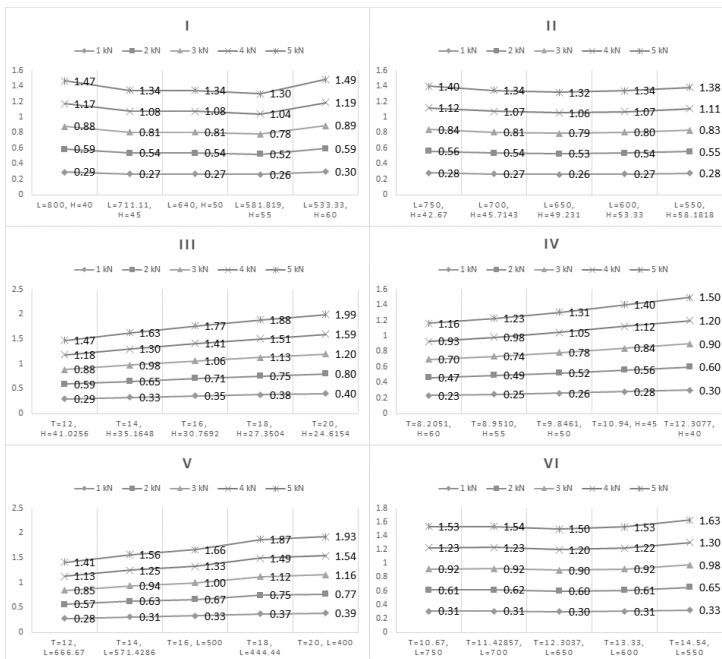

Fig-7: Maximum deflection for point load and simply supported edges condition

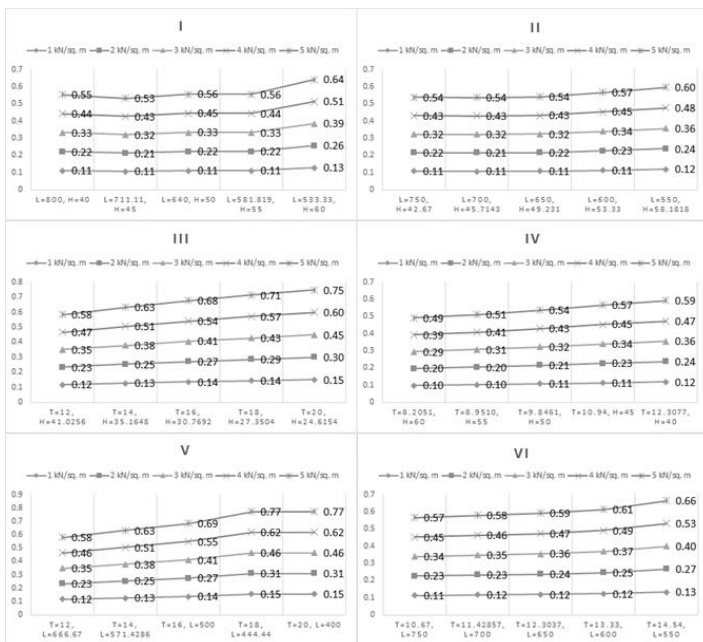

Fig-8: Maximum deflection for uniformly distributed load and simply supported edges condition

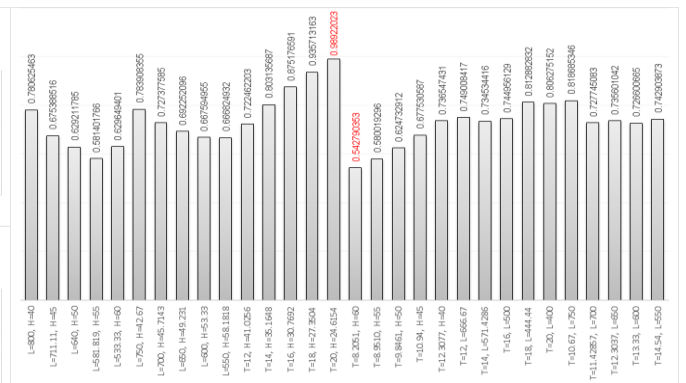

Fig-9: Maximum deflection for point load (5 kN) and fixed edges condition

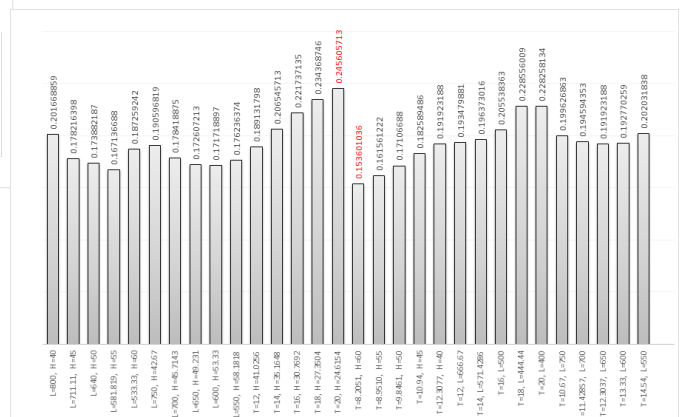

Fig-10: Maximum deflection for uniformly distributed load (5 kN/m²) and fixed edges condition

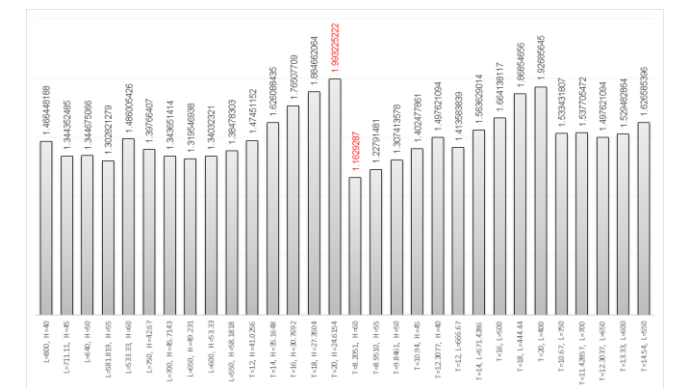

Fig-11: Maximum deflection for point load (5 kN) and simply supported edges condition

4.3 Example-3: A parametric study is carried out further for 5 kN and 5 kN/m² loads for different boundary conditions with different combinations of stiffener plate geometry. It is found that the variation in the deflection of stiffened plate is very less when the load is minimum. If the load is increased the variation in deflection is quite appreciable. So, it is very important to analyze the stiffened plate at higher loads. The obtained results are shown in Figures 9, 10, 11 and 12.

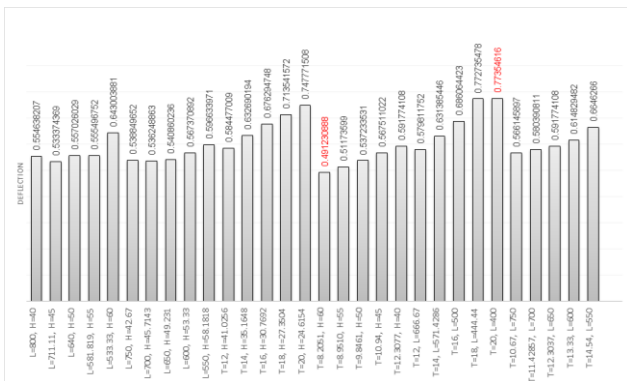

Fig-12: Maximum deflection for uniformly distributed load (5 kN) and simply supported edges condition

deflection and the corresponding stress for varying both the loading and boundary conditions. It is observed that the maximum deflection is not occurred at that point at which the stiffened plate is having high stress, which is not similar to that of bare plate.

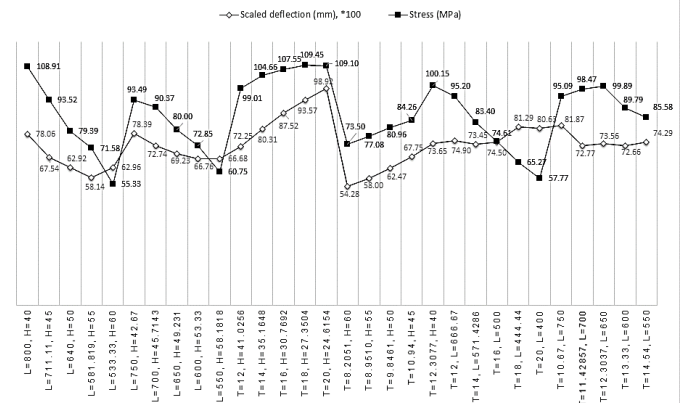

Fig-13: Maximum deflection (scaled = 100) and stress generated for point load (5 kN) and fixed edges

4.4 Example-4: In this example, a bare plate is analysed to estimate the deflection and the corresponding stress. The obtained results are presented in Table-3. It is found that the maximum deflection is occurred at that point at which the plate is having high stress.

Table-3: Maximum deflection and stress for bare square plate

		Point Load (kN)				
		1.0	2.0	3.0	4.0	5.0
Fixed edge	Max. stress	15.68	31.37	47.05	62.74	78.43
	Max. deflection	00.30	00.61	00.91	01.22	01.52
Simply supported edge	Max. stress	18.91	37.83	56.75	75.66	94.58
	Maximum deflection	00.63	01.26	01.90	02.53	03.17
		Distributed Load (kN/m ²)				
		1.0	2.0	3.0	4.0	5.0
Fixed edge	Maximum stress	02.22	04.44	06.66	08.88	11.10
	Maximum deflection	00.06	00.13	00.20	00.27	00.34
Simply supported edge	Maximum stress	03.22	06.45	09.68	12.90	16.13
	Maximum deflection	00.22	00.44	00.66	00.88	01.11

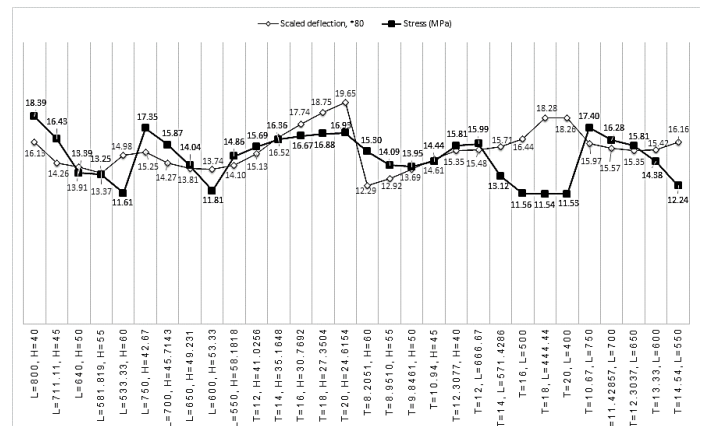

Fig-14: Maximum deflection (scaled = 80) and stress generated for uniformly distributed load (5 kN/m²) and fixed edges condition

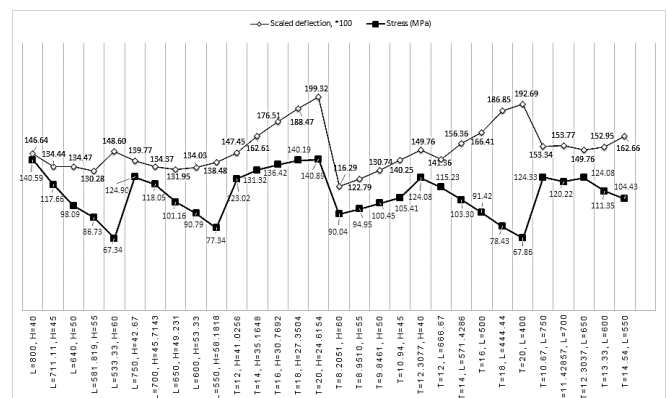

Fig-15: Maximum deflection (scaled = 100) stress generated for point load (5 kN) and simply supported edges condition

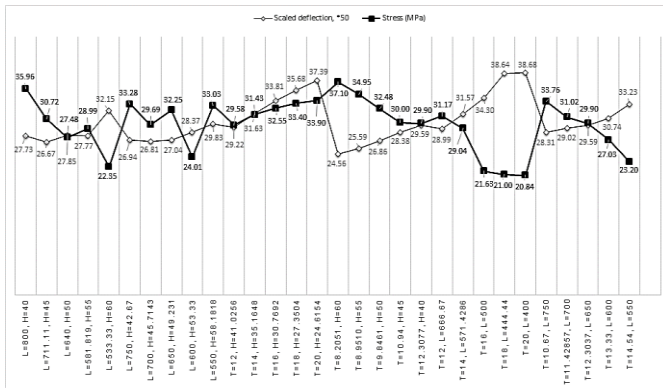

Fig-16: Maximum deflection (scaled =50) stress generated for uniformly distributed load (5 kN/m²) and simply supported edges condition

5. CONCLUSIONS

The variation in the deflection of stiffened plates is presented in this paper. The geometry of stiffener is varied keeping the constant volume of material. The stiffened plate is analysed for different loading conditions subjected to different boundary conditions. Following are the conclusions:

- At lower loading conditions, there is a meager variation in the deflection for fixed and simply supported edges boundary conditions. However, at higher loading conditions, variation in the deflection value is noticeable.
- The geometry of the stiffeners may be recommended as follows:
 - Thickness of stiffener should be approximately equal to the thickness of the plate.
 - Length of stiffener should be 65% to 75% of the width of the plate.
 - Height of the stiffener should be 4 to 6 times more than its thickness.

REFERENCES

1. Charles R. Steele, Chad D. Balch, Introduction to the Theory of Plates, Lecture notes, Stanford University
2. Piaras Kelly, Solid Mechanics II, Lecture notes, University of Auckland
3. Mazin Victor Yousif, Nazar Kais M. Naief, Yahya M. Hamad, "Optimum height of plate stiffener under pressure effect", The 1st Regional Conference of Eng. Sci. NUCEJ Spatial ISSUE (2008), vol.11, No.3, pp. 459-468
4. Jafarpour Hamedani, Shahed, and Ahmad Rahbar Ranji. "Buckling analysis of stiffened plates subjected to non-uniform biaxial compressive loads using conventional and super finite elements", Thin-Walled Structures (2013)

5. M. V. Dharaneepathy, K. G. Sudhesh, "Optimal stiffening of square plates subjected to air-blast loading", Computers and Structures (1990)
6. Mohammed M. Hasan, "Optimum design of stiffened square plates for longitudinal and square ribs", University of Anbar (2007)
7. Omri Pedatzur, "An Evaluation of Finite Element Models of Stiffened Plates Subjected to Impulsive Loading", Tel Aviv University (2005)
8. Zoltan Virag, "Optimum design of stiffened plates for different load and shapes of ribs", Journal of Computational and Applied Mechanics (2004)
9. Bashir Behjat, Amin Paykani, Amir Afkar, "Analysis of Deflection of Rectangular Plates under Different Loading Conditions", International Journal of Natural and Engineering Science (2012)
10. Timoshenko, Woinowsky-Krieger, Theory of plates and shells, McGraw-Hill New York (1959)

BIOGRAPHIES



Mr. Deepak Kumar Singh is the Research Scholar in the Department of Civil Engineering at Motilal Nehru National Institute of Technology, Allahabad, India.



Dr. S. K. Duggal is currently Professor in the Department of Civil Engineering at Motilal Nehru National Institute of Technology, Allahabad, India.



Dr. P. Pal is currently Assistant Professor in the Department of Civil Engineering at Motilal Nehru National Institute of Technology, Allahabad, India.