

# Evaluation and Comparison of Behaviour of Trapezoidally Corrugated Steel Plate Shear Walls

Amrutha Rajeev<sup>1</sup>, Bobby Jacob<sup>2</sup>, Sibin Muhamed<sup>3</sup>

<sup>1</sup>P. G Scholar, Civil Engineering, M A College of Engineering, Kothamangalam, Ernakulum, Kerala, India

<sup>2</sup>Assistant Professor, Civil Engineering, M A College of Engineering, Kothamangalam, Ernakulum, Kerala, India

<sup>3</sup>Research Scholar, Department of Ocean Engineering, Indian Institute of Technology, Madras, India

\*\*\*

**Abstract** - Corrugated Steel Plate Shear Wall construction is relatively new, innovative and efficient lateral force resisting construction. This system has great advantages compared to other similar systems such as reinforced shear walls and steel braces. This study is an investigation on the nonlinear behavior of Corrugated Steel Plate Shear walls under cyclic and monotonic loading condition. A parametric study is conducted on geometrically different Corrugated Steel Shear Walls for the detailed investigation on the seismic performance of the steel plate shear wall system. Parameters studied are infill plate thickness, opening percentages and direction of corrugation. The present study results indicates that, under lateral loading horizontally aligned Corrugated Steel Plate Shear Walls as well as vertically aligned Corrugated Steel Plate Shear Walls have almost same behavior, and different opening percentages have more and less effect on ultimate load, stiffness and ductility respectively.

**Key Words:** Horizontally aligned Corrugated Steel Plate Shear Walls, Vertically aligned Corrugated Steel Plate Shear Walls, Corrugated Steel Plate Shear Walls Openings, infill plate, ultimate load, ductility, stiffness.

## 1. INTRODUCTION

Since 1970's, steel plate shear walls have been used as efficient and widely constructed primary lateral force resisting system particularly in areas of high seismic hazard in several modern and important structure. Significant strength, ductility and initial stiffness at relatively low cost and short construction are the primary motivations for the construction type. Much lighter weight, faster erection process, much easier and faster retrofit applications are the other major advantages of the Steel Plate Shear Wall system. The seismic behavior of them is not as well as understood as other commonly used systems, such as concentrically braced frames and moment frames as there are a limited number of buildings with steel plate shear wall lateral systems that have been subjected to large earthquakes.

The main function of the shear wall is to resist horizontal story shear and overturning moment due to lateral loads. In general, steel plate shear wall system consists of a steel infill plate or wall plate, two boundary columns and horizontal floor beams.

Corrugated Steel Plate Shear wall is a relatively new, untested, and innovative steel shear wall construction that mitigates the early buckling behavior of steel shear walls. The investigations of steel shear walls with corrugated plates are limited. The stiffeners around openings are introduced into the shear wall design to limit the shear buckling and preserve the shear capacity of plate. However, stiffener fabrication and installation significantly increases material and labor costs in addition to added inspection requirements. Therefore, a corrugated shear panel is proposed as a viable alternative to simple, stiffened steel plate shear walls as the need for stiffeners is eliminated, particularly around openings. Due to out-of-plane stiffness, trapezoidal corrugated infill plate's present significant initial stiffness, as each corrugation supports adjacent corrugations in the out-of-plane direction [1-4].

The objectives for the present study are, prediction of ultimate load, ductility and stiffness as function of shear wall geometry and then evaluate and compare the behavior of Corrugated Steel Plate Shear Walls on the basis of analysis result obtained which includes, effect of different thicknesses, effect of different opening percentages and effect of corrugation direction. Failure modes and buckling analysis are out of scope of the study.

A detailed finite element analysis has been conducted on 42 models of Corrugated Steel Plate Shear wall with and without opening and two different corrugation directions in the execution of parametric study that includes; infill plate thickness, opening percentages and corrugation direction.

## 2. VALIDATIONS FOR FINITE ELEMENT ANALYSIS

To establish the accuracy of the numerical modeling methodology, finite element model of tested specimen of Corrugated Steel Shear Wall is developed and compared it with a well established laboratory test, for this Vertically Corrugated Steel Plate Shear Wall tested by Emami and Mofid was considered [5].

### 2.1 Experimental Program Details

In experimental research trapezoidal vertically Corrugated Steel Shear Wall is constructed in half scale, one story and single bay. The shear panel was 2000mm wide and 1500mm height and with thickness of 1.25mm. For the boundary frame of the specimen, the top beam section is HE-B 140, the bottom beam section specimen is HE-B 200 and section of column is HE-B 160, which is connected to the strong floor beam of the laboratory.



Fig -1: Experimental Setup of Specimen

To implement lateral load and to investigate the behavior of the specimen in lab, quasi- static cyclic load is applied by two horizontal hydraulic jacks on both side at top beam level using AC protocol. In this study loading was conducted as displacement controlled and gravity loads were not applied [5]. The experimental setup of the specimen is shown in Fig 1.

### 2.2 Numerical Model Details

The simulations were undertaken using the commercially available finite element package of ANSYS 16.2. The model was constructed using the general purpose four node shell element that is capable of large displacement and non linear behavior. This shell element was used for all components of the structure including the standard rolled section.

As described, numerical model according to the as-built dimension of the tested specimen was modeled and analyzed

in ANSYS 16.2. The beams to columns were moment resisting, therefore all intersecting shell elements were directly connected. The steel wall is connected directly and continuously to the beams and columns as suggested by Emami and Mofid [5]. The numerical model of the specimen is shown in Fig 2.

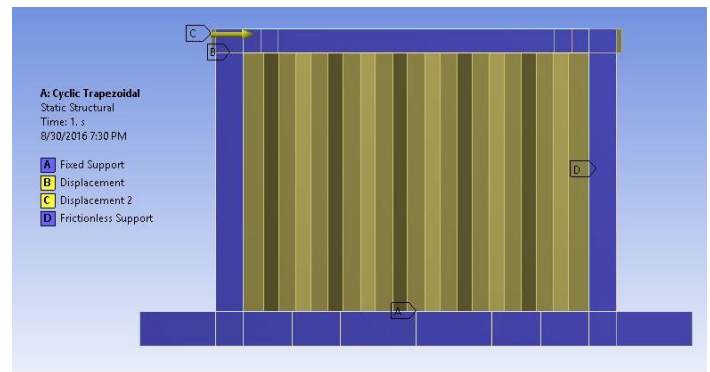


Fig -2: Numerical Model

The yield strength of plate, beam and column are 224 MPa, 254 MPa and 280 MPa respectively. Young's modulus of elasticity and Poisson's ratio are considered to be 200GPa and 0.3 for all steel material.

### 2.3 Assumptions and Validation of Modeling

The simulations were performed under displacement controlled loading with the aid of a non - linear static procedure. The hysteresis curve of quasi- static cyclic loading generated from the finite element analysis is compared with the experimental test result.

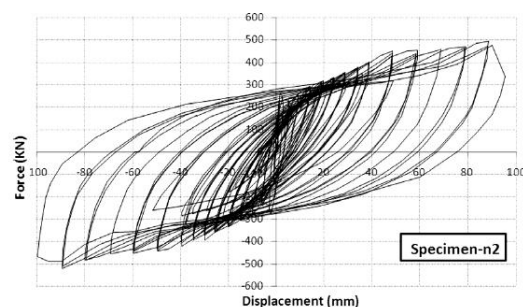


Fig -3: Hysteresis Behavior of Tested Specimen

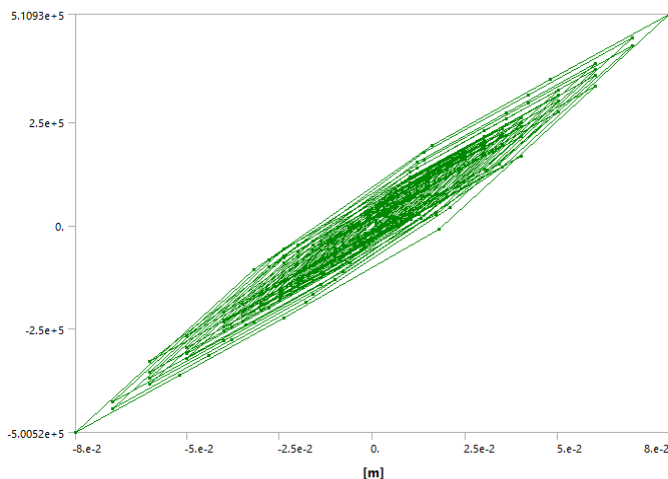


Fig -4: Hysteresis Behavior of Numerical Model

Excellent agreement is observed between analysis and experimental results. For the numerical model of Corrugated Steel Plate Shear Wall the peak load observed during the test is underestimated only by 4% as shown in Fig 3-4. Minor differences in the result of comparison presented are due to the type of verification.

### 3. PARAMETRIC STUDY DESIGN

The overall seismic performance of a steel shear wall depends upon geometrical properties of the boundary elements as well as the infill plates. Therefore for the detailed investigation on the seismic performance of the steel plate shear wall system, parametric studies are performed by changing the geometric properties of the infill plate.

Table -1: Specification Chart for Numerical Models

Modal Name	Thickness [A] (mm)	Opening Percentage [B] (%)	Direction of Corrugation[C]
[C]CT[A]	1.5,2,2.5, 3.25,4	NA	Vertical (V) Horizontal (H)
CT[A]OP[B]	1.5,2,2.5, 3.25,4	5,10,15,25	Vertical [V]

Parameters considered including thickness of infill plate, opening percentage, and direction of corrugation. On this basis 42 models are considered. The specification chart for the numerical models is given in Table 1. Five different plate thicknesses are considered based on common values mentioned in the published literatures [3]. Thicknesses are 1.5mm, 2mm, 2.5mm, 3.25mm and 4mm respectively. Opening percentages taken as an area equal to 5%, 10%, 15% and 25% of the infill plate area. In the case of direction, vertical and horizontal alignments of infill plates are considered. Specification of different models considered for the parametric study is illustrated in Table 1.

### 4. NUMERICAL MODELING AND SIMULATION

The validated finite element models are used for the modeling and analysis of all the geometrically different steel shear walls.

#### 4.1 Finite Element Modeling and Element Selection

Finite Element Analysis is more reliable for the analysis of steel shear wall. The simulations were undertaken using commercially available finite element package ANSYS 16.2 Workbench.

SHELL181 is suitable for analyzing thin to moderately-thick shell structures. It is a four-node element with six degrees of freedom at each node: translations in the x, y, and z directions, and rotations about the x, y, and z-axes. Finite Element Analysis is more reliable for the analysis of steel shear wall. SHELL181 is well-suited for linear, large rotation and large strain nonlinear applications.

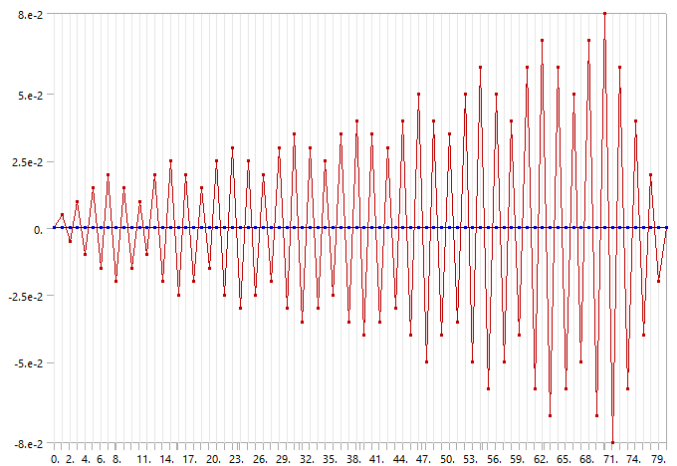
#### 4.2 Boundary Conditions and Material Properties

Boundary conditions are provided according to the experimental setup. The bottom edge of the infill panel and the base of the columns were fixed in each finite element models. The beams to column connections are moment resisting therefore the entire intersecting shell element are directly connected. The steel shear wall is connected directly and continuously to columns and beams. To prevent the out of plane movement of the frame, the beam to column connection of each finite element model were restrained from the global z direction.

The boundary element dimensions in each finite element models are illustrated in Table 2 and the material properties of all the steel materials are illustrated in Table 3.

**Table -2:** The Boundary Element Dimensions

Design of specimen	Profile	Web Height (mm)	Web thickness (mm)	Flange Width (mm)	Flange thickness (mm)
Top Beam	HEB 280	280	10	280	18
Columns	HEB 320	320	11	300	20
Bottom Beam	HEB 400	400	13	300	24



**Fig -5:** Quasi- Static Displacement Control Loading Sequence

**Table -3:** Material Properties all Steel Materials

Type	Young's modulus (GPa)	Poisson's Ratio	Tensile yield strength (MPa)	Tensile ultimate strength (MPa)
Plate	200	0.3	224	315
Beam	200	0.3	254	383
Column	200	0.3	280	423
Stiffener	200	0.3	313	490

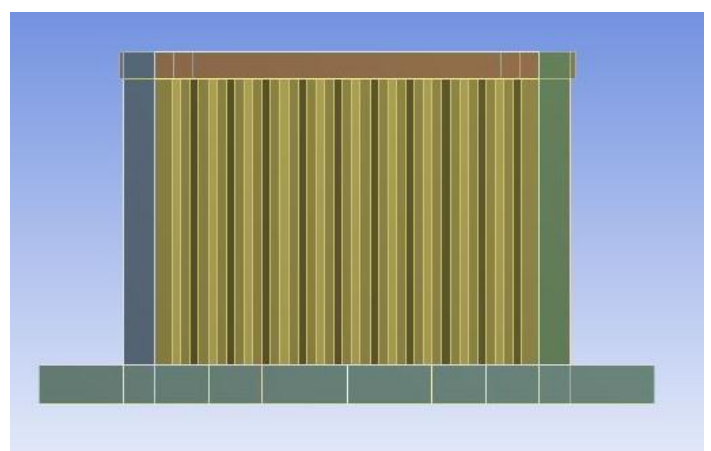
**4.3 Loading Program**

To simulate earthquake load and further to investigate the behavior of shear wall two types of loading programs were employed, quasi static cyclic loading and monotonic loading.

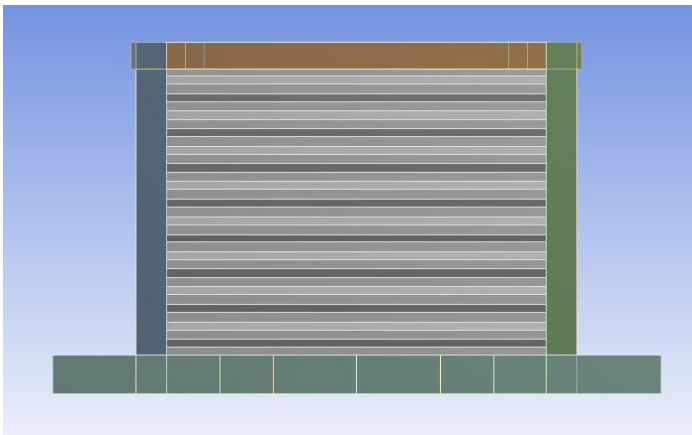
Quasi static cyclic load simulations were performed under displacement controlled loading. Quasi- static displacement control loading sequence applied at the top of the wall is shown in Fig 5. For each model monotonic loading was applied up to specimens ultimate load were reached.

**4.4 Numerical Models Used for the Study**

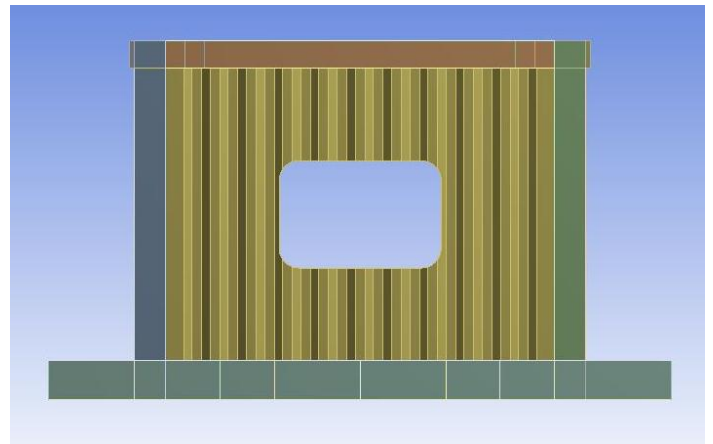
For the investigation of the behavior of steel plate shear walls under lateral loading, Vertically Corrugated Steel Plate Shear Walls, Horizontally Corrugated Steel Plate Shear Walls and Corrugated Steel Plate Shear Wall with openings are considered. Different numerical models used in the study are shown in Fig 6- 11.



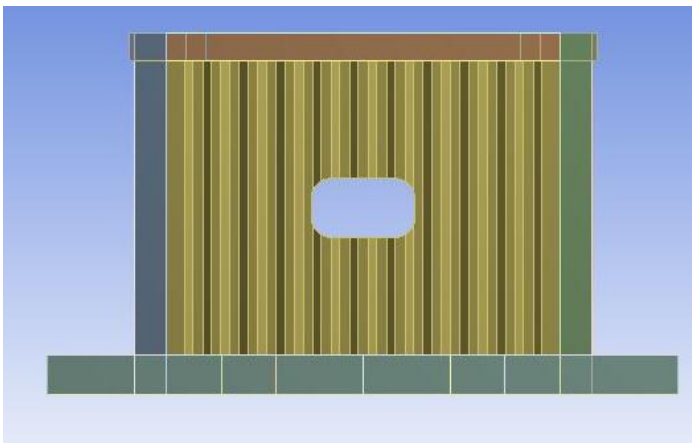
**Fig -6:** Vertically Corrugated Steel Plate Shear Wall



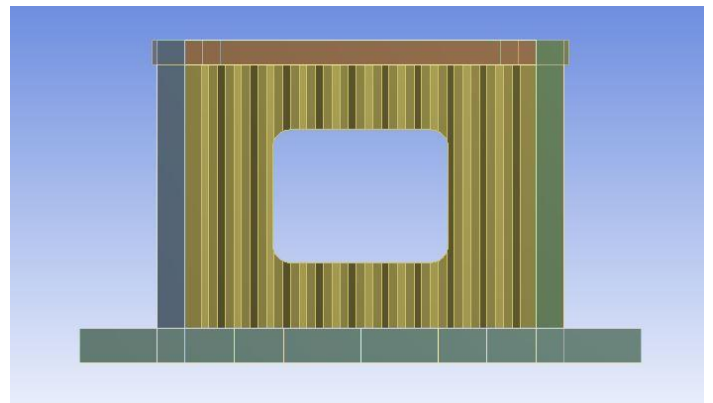
**Fig -7:** Horizontally Corrugated Steel Plate Shear Walls



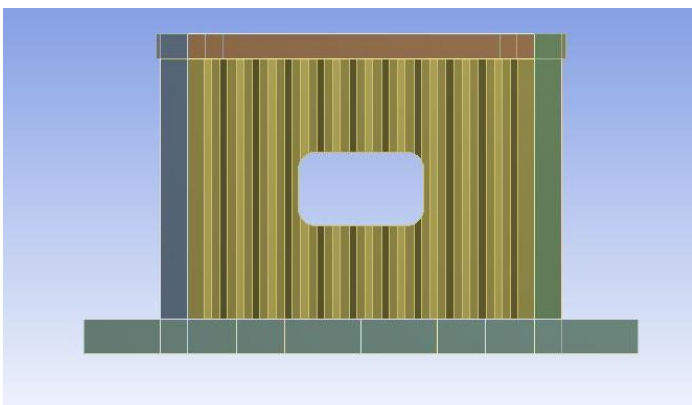
**Fig -10:** Corrugated Steel Plate Shear Wall with 15% opening



**Fig -8:** Corrugated Steel Plate Shear Wall with 5% opening



**Fig -11:** Corrugated Steel Plate Shear Wall with 25% opening



**Fig -9:** Corrugated Steel Plate Shear Wall with 10% opening

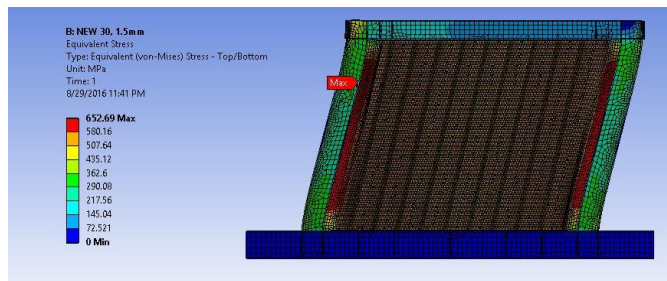
All the geometrically different steel plate shear walls have the same boundary conditions and material properties. The height and length of the story panel are 3m and 4m respectively correspond to the conventional dimension of the shear wall in the building were assumed.

Trapezoidally corrugated steel plate shear walls with 30 degree corrugation angle and 50mm corrugation depth were considered for the study. Each vertically corrugated panel consists of 10 corrugation half waves and 8 corrugation half waves in horizontally corrugated shear panels.

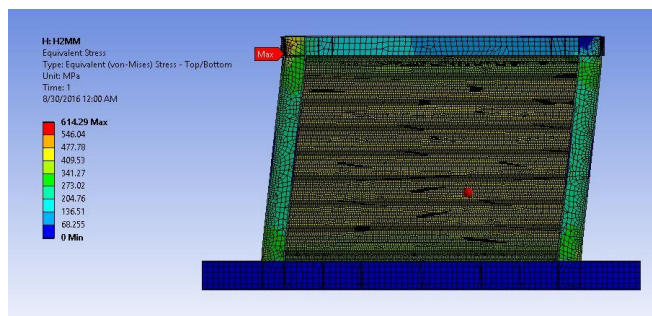
## 5. NON- LINEAR STATIC ANALYSIS OF SHEAR WALLS UNDER MONOTONIC AND CYCLIC LOADING

The important properties of structures, which contribute to their elastic resistance under moderate earthquakes, are its yield strength and elastic stiffness. During a severe earthquake, the structure is likely to undergo inelastic

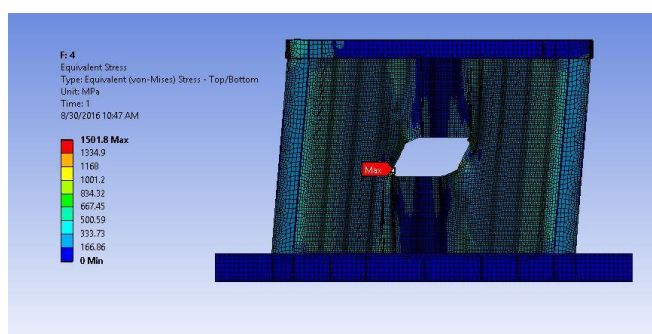
deformations and has to rely on its ductility and hysteretic energy dissipation capacity to avoid collapse. Equivalent stress patterns of different models are shown in Fig 12-17.



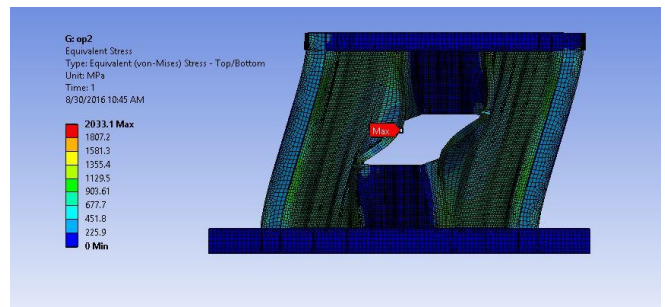
**Fig -12:** Equivalent Stress Pattern of Vertically Corrugated Steel Plate Shear Wall



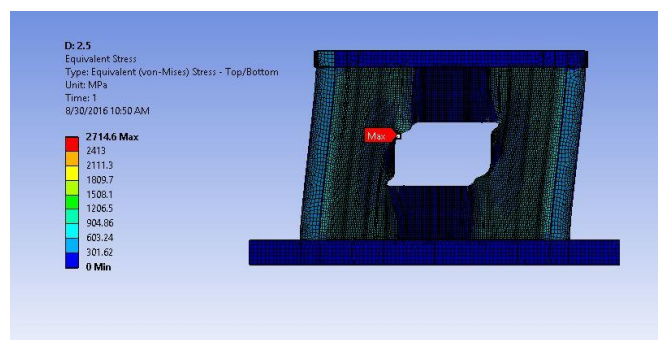
**Fig -13:** Equivalent Stress Pattern of Horizontally Corrugated Steel Plate Shear Wall



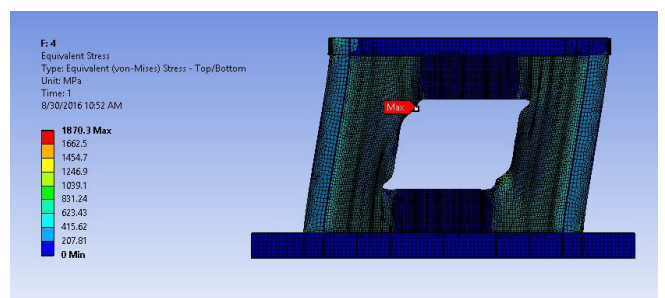
**Fig -14:** Equivalent Stress Pattern of Corrugated Steel Plate Shear Wall with 5% opening



**Fig -15:** Equivalent Stress Pattern of Corrugated Steel Plate Shear Wall with 10 % opening



**Fig -16:** Equivalent Stress Pattern of Corrugated Steel Plate Shear Wall with 15% opening



**Fig -17:** Equivalent Stress Pattern of Corrugated Steel Plate Shear Wall with 25% opening

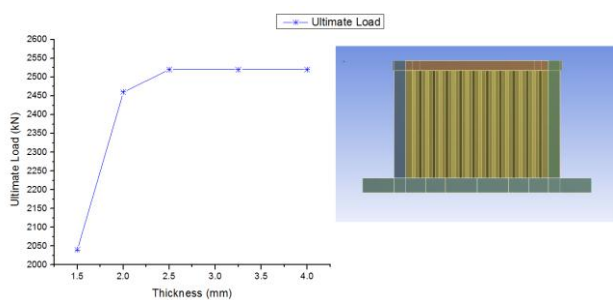
Variation of ultimate strength, ductility and stiffness are the main characteristics which affects the seismic performance of the steel shear wall. Considering the significance of these characteristics of lateral force resisting system, the performance of steel plate shear wall models in terms of ultimate load, ductility and stiffness are find out through the assessment of numerical results from non- linear static analysis of models under monotonic and cyclic loading.

## 6. EVALUATION OF PARAMETRIC STUDY RESULTS

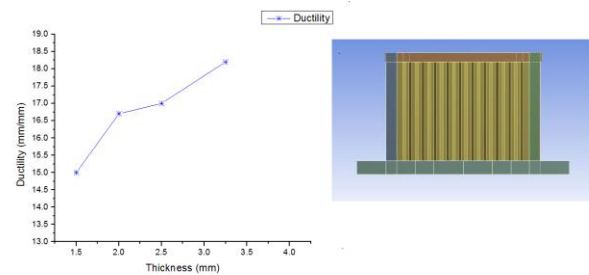
The results of nonlinear static analysis of Corrugated Steel Plate Shear Walls under monotonic loading condition are presented here.

### 6.1 Case 1: Vertically Corrugated Steel Plate Shear Walls

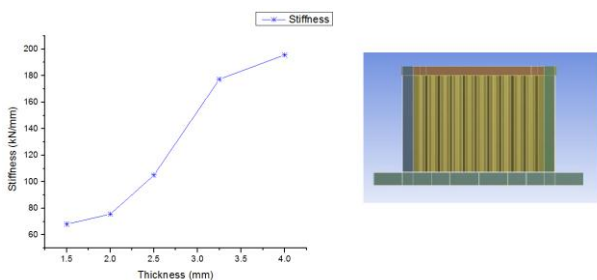
Ultimate load, ductility and stiffness of Vertically Corrugated Steel Plate Shear Walls as a function of thickness are illustrated in Chart 1-3.



**Chart -1:** Ultimate Load Vs Thickness Curve of Vertically Corrugated Steel Plate Shear Walls



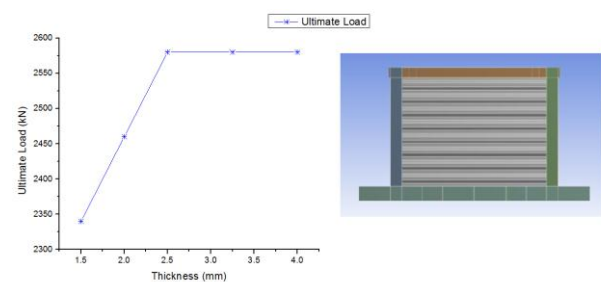
**Chart -2:** Ductility Vs Thickness Curve of Vertically Corrugated Steel Plate Shear Walls



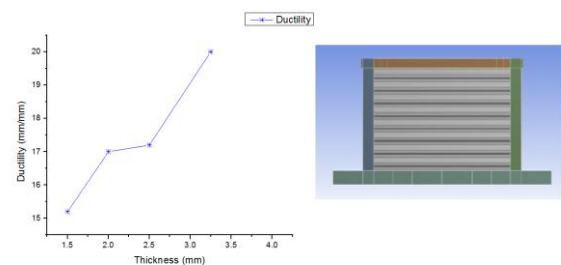
**Chart -3:** Stiffness Vs Thickness Curve of Vertically Corrugated Steel Plate Shear Walls

### 6.2 Case 2: Horizontally Corrugated Steel Plate Shear Walls

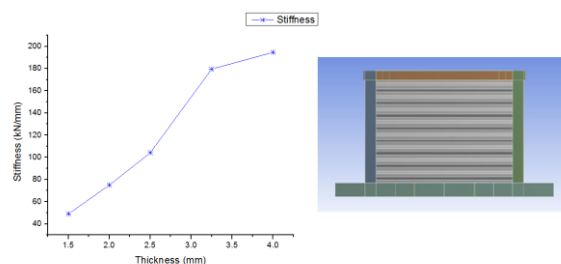
Ultimate load, ductility and stiffness of Horizontally Corrugated Steel Plate Shear Walls as a function of thickness are illustrated in Chart 4-6.



**Chart -4:** Ultimate Load Vs Thickness Curve of Horizontally Corrugated Steel Plate Shear Walls



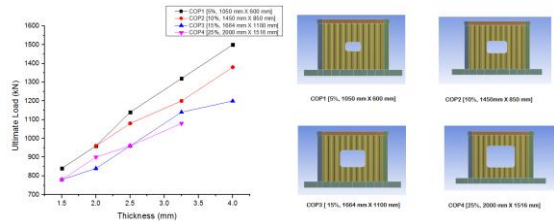
**Chart -5:** Ductility Vs Thickness Curve of Horizontally Corrugated Steel Plate Shear Walls



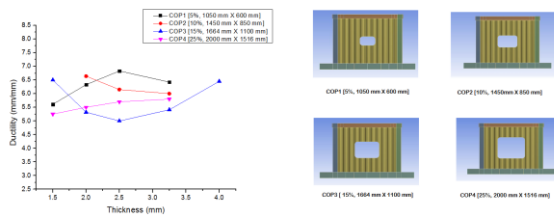
**Chart -6:** Stiffness Vs Thickness Curve of Horizontally Corrugated Steel Plate Shear Walls

### 6.3 Case 3: Corrugated Steel Shear Walls with openings

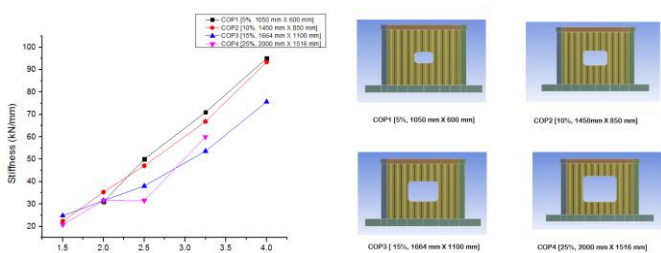
Ultimate load, ductility and stiffness of Corrugated Steel Plate Shear Walls with openings as a function of thickness are illustrated in Chart 7-9.



**Chart -7:** Ultimate Load Vs Thickness Curve of Corrugated Steel Plate Shear Walls with openings



**Chart -8:** Ductility Vs Thickness Curve of Corrugated Steel Plate Shear Walls with openings

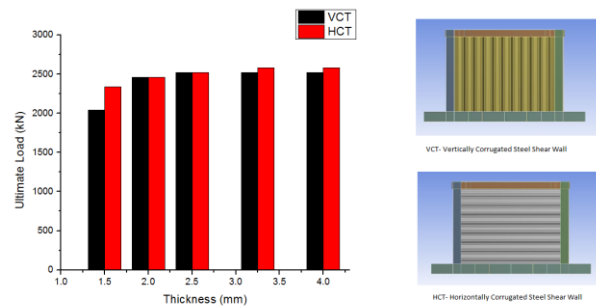


**Chart -9:** Stiffness Vs Thickness Curve of Corrugated Steel Plate Shear Walls with openings

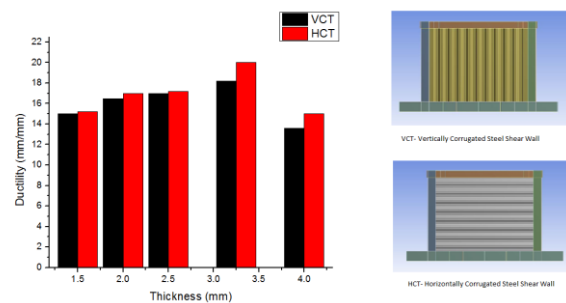
## 7. COMPARISON OF PARAMETRIC STUDY RESULTS

### 7.1 Case 1: Comparison of Vertically Corrugated Steel Shear Walls and Horizontally Corrugated Steel Shear Walls

Comparisons of response of Vertically Corrugated Steel Plate Shear Walls and Horizontally Corrugated Steel Plate Shear Walls are presented as a function of infill plate thickness in chart 10-12. It can be observed from the charts that, there is no significant difference in the behavior of both types of the shear walls. Both vertically aligned and horizontally aligned shear walls have almost same values of strength, ductility and stiffness. However in the case of ultimate load at higher thicknesses, horizontally aligned steel shear wall shows 2.38% increase compared to that of vertically aligned. From this comparison it can be concluded that under lateral loading condition direction of corrugation have no significant effect on the behavior of steel shear walls.

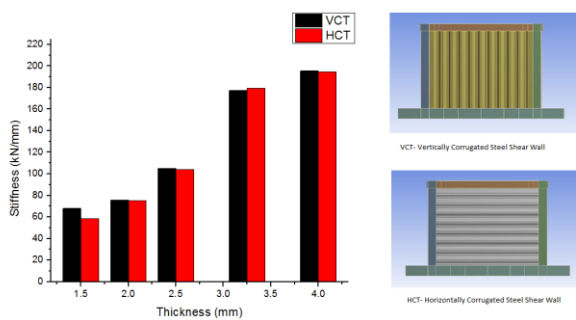


**Chart -10:** Comparison of Ultimate Load of Vertically Corrugated Steel Shear Walls and Horizontally Corrugated Steel Shear Walls



**Chart -11:** Comparison of Ductility of Vertically Corrugated Steel Shear Walls and Horizontally Corrugated Steel Shear Walls

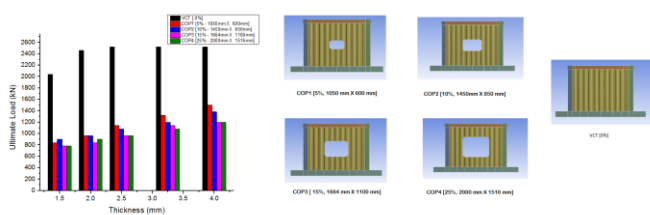




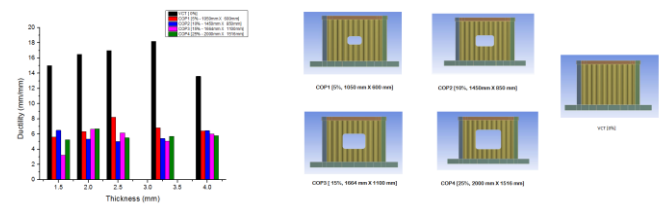
**Chart -12:** Comparison of Stiffness of Vertically Corrugated Steel Shear Walls and Horizontally Corrugated Steel Shear Walls

### 7.2 Case 2: Comparison of Corrugated Steel Shear Walls with and without opening

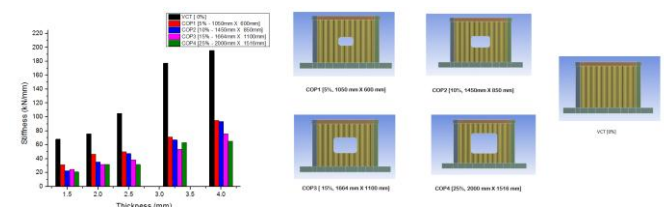
Comparisons of response of Corrugated Steel Shear Walls with and without opening are presented as a function of thickness in Chart 13-15. It can be observed from the charts that, behavior of corrugated plates without openings is superior to that of shear walls with openings. The increase in thickness of infill plate increase ultimate strength, ductility and stiffness of shear wall system. Provision of 5% opening in infill plates results in considerable drop in the ultimate load, ductility and stiffness while, increase in opening percentage from 5% to 25% is comparatively less effective in reducing the same. Ductility of the Corrugated Steel Shear Wall with opening shows scatter results it seems that ductility of shear walls with openings is not affected remarkably by the variation of thickness of the infill plates.



**Chart -13:** Comparison of Ultimate Load of Corrugated Steel Shear Walls with and without opening



**Chart -14:** Comparison of Ductility of Corrugated Steel Shear Walls with and without opening



**Chart -15:** Comparison of Stiffness of Corrugated Steel Shear Walls with and without opening

## 8. CONCLUSIONS

In this study the behavior of Corrugated Steel Shear Walls with different corrugation direction, with and without openings have been investigated using Finite Element software in ANSYS16.2. Numerous finite element models were considered based on infill plate thickness, opening percentage and direction of opening. Under the scope of the work following observations and conclusions are drawn from the present study.

- The infill plate thicknesses found to be an important geometric property of shear wall system. Increase in thickness in small range will leads to a large increase of stiffness of the shear wall system. This behavior of shear wall can reduce non-structural damage of the structure under earthquake
- Under lateral loading Vertically Corrugated Steel Shear Wall and Horizontally Corrugated Steel Shear Wall shows almost same behavior. Thus direction of corrugation is found to be less effective in the behavior of Steel Plate Shear Wall.
- Introduction of web plate perforation and increasing of percentage of opening shown to have detrimental effects by reducing ultimate load and stiffness of the shear wall system, while ductility of the system was not affected significantly by the variation of opening percentages.

## ACKNOWLEDGEMENT

The authors would like to thank MA College of Engineering for the support and cooperation.

## REFERENCES

- [1] Jeffrey W. Berman and Michel Bruneau, "Experimental Investigation of Light-Gauge Steel Plate Shear Walls", Journal of Structural Engineering, Vol. 131(2), 2005.
- [2] M. Gholizadehand Y.Yadollahi, "Comparing Steel Plate Shear Wall Behavior with Simple and Corrugated Plates", Applied Mechanics and Materials, Vol. 147, 2011, pp. 80-85.
- [3] Hamed Kalali, Farshid Alae, Tadeh Zirakian and Mohammad Hajsadeghi, "Hysteretic performance of SPSWs with trapezoidally horizontal corrugated web-plates", Steel and Composite structures, An International Journals, Vol 19, 2015.
- [4] Mahmoud Bayat, Y. Yadollahi and I.Pakar, "Evaluation and Comparison of Corrugated Steel Plate Shear Walls", Latin American Journal of Solids and Structures, Vol (12), 2015, pp 763-786.
- [5] Fereshteh Emami, Mahmoud Mofid and A. Vafai, "Experimental study on cyclic behavior of trapezoidally corrugated steel shear walls", Article in Engineering Structures, Vol (48), 2013, pp. 750-762.
- [6] Mahmoud Bayat, Y. Yadollahi and I.Pakar, "Evaluation and Comparison of Corrugated Steel Plate Shear Walls", Latin American Journal of Solids and Structures, Vol (12), 2015, pp 763-786.
- [7] Milad Bahrebar, Tadeh Zirakian and Mohammad Hajsadegh, "Nonlinear buckling analysis of steel plate shear walls with trapezoidally- corrugated and perforated infill plates", Proceedings of the Annual Stability Conference, Structural Stability Research Council, 2015.