

FUZZYBASED TRANSFORMERLESS SINGLE-PHASE UNIVERSAL APF FOR HARMONIC AND REACTIVE POWER COMPENSATION

D. Surendra¹, S. M.rama sekhar reddy²

¹PG Scholar, Dept. Of Electrical & Electronics Engineering, JNTUACEA, Anantapuramu, A.P., India

²Assistant professor, incharge HEAD, JNTUA College of Engineering, Kalikiri,, A.P., India

ABSTRACT- In this paper, a universal active filter was developed with fuzzy logic controller for harmonic and reactive power compensation for single-phase systems applications. APF can correct the power quality and improve the reliability and stability on power utility. The proposed system is a combination of parallel and series active filters without transformer. It reduces the lower order harmonics and thus effectively reduces total harmonic distortion. Here we are using fuzzy logic controller instead of using other controllers. The model of the system is derived and it is shown that the circulating current observed in the proposed active filter is an important quantity that must be controlled. A complete control system, including pulse width modulation (PWM) techniques, is developed. The simulation was done by using MATLAB/Simulink software.

INDEX TERMS: Optimum voltage angle, single-phase configuration, total harmonic distortion, universal active power filter (UAPF), Fuzzy logic controller.

I. INTRODUCTION

Sensitive loads are greatly affected by power-quality (PQ) disturbances in the system. The increased NON-Linear loads today's life increase the distortion which causes Voltage Swell and sag. The strict requirement of power quality at input ac mains and the output load (sensitive loads) in the area of power line conditioning is very important in power electronics. Different equipments are used to improve the power quality, e.g., transient suppressors, line voltage regulators, uninterruptible power supplies, active filters, and hybrid filters. The continuous proliferation of electronic equipment either for home appliance or industrial use has the drawback of increasing the non sinusoidal current into power network. Thus, the need for economical power conditioners for single-phase systems is growing rapidly. Different mitigation solutions are currently proposed and used in practice applications to work out the problems of harmonics in electric grids.

There are many studies about harmonic distortion with techniques to improve power quality and compensate distorted signal. Usually, when a passive LC (Inductor and Capacitor) power filter is connected in parallel with the load, of parallel or series resonances because of which the passive filter cannot provide a complete solution it is used to eliminate current harmonics. This compensation equipment has some

defects mainly related to the appearance. For eliminating harmonic pollution in power systems, the active power filter (APF) is a very suitable tool. APF has to respond instantaneously and work with high control precision in current tracking, since the load harmonics may be very complicated and change randomly and quickly. Many advanced control and signal-processing techniques have been applied, such as pulse width modulation (PWM), hysteresis band current control (HBCC), sliding-mode control, fuzzy-logic control, neural-network theory, and adaptive signal processing and etc.

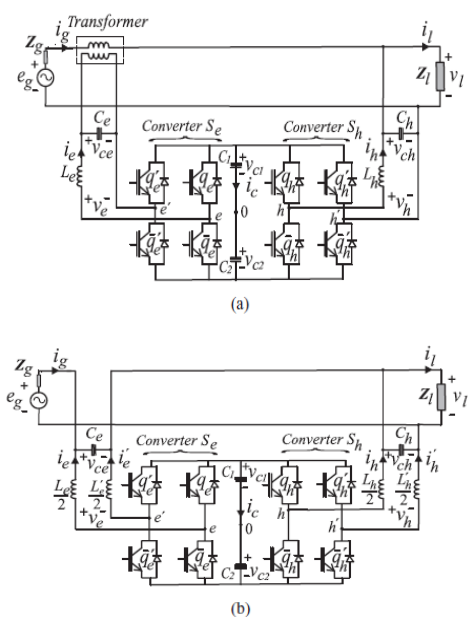

Fig. 1. Single-phase UAPF: (a) conventional structure and (b) transformer-less proposed structure.

Over the past few decades, the use of active filtering techniques has become more attractive due to the technological progress in power electronic switching devices, enhanced numerical methods, and more efficient control algorithms. The series active power filter (SAPF) provides load voltage control eliminating voltage disturbances, such as unbalance, sags, notches, flickers, and voltage harmonics, so that a regulated fundamental load voltage with constant magnitude is provided to the load. The purpose of a parallel active power filter (PAPF) is to absorb harmonic currents, compensate for reactive power, and regulate the dc-bus voltage between both active filters. The universal active power filter (UAPF)

which is a combination of both, is a versatile device that operates as series and parallel active power filter.

It can simultaneously fulfill different objectives like maintaining a sinusoidal voltage (harmonic free) at the load, source current harmonics elimination, load balance, and power factor correction. The cost and size associated with the transformer makes undesirable such a solution, mainly for office and home environments. This paper proposes an universal active filter topology for single-phase systems applications without transformer, as shown in Fig. 1(b). A complete control system, including pulse-width modulation (PWM) techniques, I developed. Comparisons between the structures are made from weighted total harmonic distortion (WTHD). The steady-state analysis is also presented in order to demonstrate the possibility to obtain an optimum voltage angle reducing the current amplitude of both series and parallel converters and, consequently, the total losses of the system.

II. MODELING OF SYSTEM

The proposed configuration shown in Fig. 1(b) comprise the grid (e_g, i_g), internal grid inductance (L_g), load Z_l (v_l, i_l), converters S_e and S_h with a capacitor bank at the dc-link and filters Z_e (L_e, L'_e , and C_e) and Z_h (L_h, L'_h and C_h). Converter S_e is composed of switches q_e, \bar{q}_e, q'_e , and \bar{q}'_e . Converter S_h is composed of switches q_h, \bar{q}_h, q'_h , and \bar{q}'_h . The conduction state of all switches is represented by a homonymous binary variable, where $q = 1$ indicates a closed switch, while $q = 0$ an open one. The converter pole voltages v_{e0}, v'_{e0}, v_{h0} , and v'_{h0} depend on the conduction states of the power switches, that is

$$v_{e0} = (2q_e - 1) \frac{v_c}{2} \quad (1)$$

$$v'_{e0} = (2q'_e - 1) \frac{v_c}{2} \quad (2)$$

$$v_{h0} = (2q_h - 1) \frac{v_c}{2} \quad (3)$$

$$v'_{h0} = (2q'_h - 1) \frac{v_c}{2} \quad (4)$$

Where v_c is the dc-link voltage.

From Fig. 1(b), the following equations can be derived:

$$v_{e0} - v'_{e0} = \left(\frac{r_e}{2} + \frac{l_e}{2}p\right)i_e - \left(\frac{r'_e}{2} + \frac{l'_e}{2}p\right)i'_e + v_g - v_l \quad (5)$$

$$v_{h0} - v'_{h0} = \left(\frac{r_h}{2} + \frac{l_h}{2}p\right)i_h - \left(\frac{r'_h}{2} + \frac{l'_h}{2}p\right)i'_h - v_l \quad (6)$$

$$v'_{e0} - v'_{h0} = \left(\frac{r'_e}{2} + \frac{l'_e}{2}p\right)i'_e - \left(\frac{r'_h}{2} + \frac{l'_h}{2}p\right)i'_h - v_l \quad (7)$$

$$v_{e0} - v_{h0} = \left(\frac{r_e}{2} + \frac{l_e}{2}p\right)i_e - \left(\frac{r_h}{2} + \frac{l_h}{2}p\right)i_h + v_g - v_l \quad (8)$$

$$e_g - v_{ce} - v_l = (r_g + l_gp)i_g \quad (9)$$

$$pv_{ce} = \frac{1}{C_e}(i_g + i_e) \quad (10)$$

$$pv_l = \frac{1}{C_h}(i_g - i_l - i'_h) \quad (11)$$

Where $p = d/dt$, $v_g = e_g - r_g i_g - l_g p i_g$, $v_l = v_{ch}$ and i_l is calculated using the load model which can be linear or nonlinear; and symbols r and l represent resistances and inductances of the inductors L_g, L_e, L'_e, L_h , and L'_h . The circulating current i_0 is defined by

$$i_0 = i_e + i'_e = -(i_h + i'_h) \quad (12)$$

The resultant circulating voltage model is obtained by adding the above equations,

$$v_0 = v'_{e0} + v_{e0} - v'_{h0} - v_{h0} \quad (13)$$

The voltage v_0 is used to compensate for the circulating current i_0 . In the balanced case, filter inductors are equal ($L_e = L'_e$ and $L_h = L'_h$) the circulating voltage model becomes

$$v_0 = v_g + \left[\left(\frac{r_e}{2} + \frac{r_h}{2}\right) + \left(\frac{l_e}{2} + \frac{l_h}{2}\right)p\right]i_0 \quad (14)$$

Thus, it can be noted that to minimize the circulating current i_0 , the voltage v_0 must be equal to v_g , i.e,

$$v_0 = v_g \quad (15)$$

When $i_0 = 0$ ($i_e = -i'_e, i_h = -i'_h$), the system model becomes

$$v_{e0} - v'_{e0} = v_g + (r_e + l_ep)i_e - v_l \quad (16)$$

$$v_{h0} - v'_{h0} = (r_h + l_hp)i_h + v_l \quad (17)$$

$$e_g - v_{ce} - v_l = (r_g + l_gp)i_g \quad (18)$$

$$pv_{ce} = \frac{1}{C_e}(i_g + i_e) \quad (19)$$

$$pv_l = \frac{1}{C_h}(i_g - i_l + i_h) \quad (20)$$

This model is similar to the model of the conventional filter with an ideal transformer. Therefore,

we can use $v_e = v_{e0} - v'_{e0}$ (converter S_e) to regulate the load voltage and $v_h = v_{h0} - v'_{h0}$ (converter S_h) to control the power factor and harmonics of i_g as in the conventional filter.

TOTAL HARMONIC DISTORTION

The WTHD values for the standard [see Fig. 1 (a)] and proposed [see Fig. 1(b)] configurations. The WTHD has been computed by using

$$WTHD(p) = \frac{100}{a_1} \sqrt{\sum_{i=2}^p \left(\frac{a_i}{i}\right)^2} \quad (21)$$

Where a_1 is the amplitude of the fundamental component is, a_i is the amplitude of i th harmonic, and p is the number of harmonics taken into consideration.

III. PWM CONTROL STRATEGY

The PWM strategy of the converters can be directly calculated from the pole voltages v'_{e0} , v_{e0} , v'_{h0} , and v_{h0} . Considering that v_e^* , v_h^* , and v_0^* denote the reference voltages requested by the controllers, it comes

$$v'_{e0} - v_{e0} = v_e^* \quad (22)$$

$$v'_{h0} - v_{h0} = v_h^* \quad (23)$$

$$v_{e0} + v'_{e0} - v_{h0} - v'_{h0} = v_0^* \quad (24)$$

These equations are insufficient to determine the four pole voltages v'_{e0} , v_{e0} , v'_{h0} , and v_{h0} . Introducing an auxiliary variable v_x^* and choosing $v'_{e0} = v_x^*$, it can be written as

$$v_{e0} = v_e^* + v_x^* \quad (25)$$

$$v'_{e0} = v_x^* \quad (26)$$

$$v_{h0} = \frac{v_e^*}{2} + \frac{v_h^*}{2} - \frac{v_0^*}{2} + v_x^* \quad (27)$$

$$v'_{h0} = \frac{v_e^*}{2} - \frac{v_h^*}{2} - \frac{v_0^*}{2} + v_x^* \quad (28)$$

Two methods are presented next in order to choose v_x^* .

Method A: General approach

In this manner, the reference voltage v_x^* is calculated by taking into account the maximum $v_c^*/2$ and minimum $-v_c^*/2$ value of the pole voltages, then

$$v_{xmax}^* = \frac{v_c^*}{2} - v_{max}^* \quad (29)$$

$$v_{xmin}^* = -\frac{v_c^*}{2} - v_{min}^* \quad (30)$$

After v_x^* is selected, all pole voltages are obtained from (25) – (28). Then, v_x^* can be chosen equal to v_{xmax}^* , v_{xmin}^* , or $v_{xave}^* = (v_{xmax}^* + v_{xmin}^*)/2$. Note that when v_{xmax}^* or v_{xmin}^* is selected, one of the converter-leg operates with zero switching frequency. On the other hand, operation with v_{xave}^* generates pulse voltage centered in the sampling period that can improve the THD of voltages. The maximum and minimum values can be alternatively used. For example, during the time interval τ choose $v_x^* = v_{xmax}^*$ and in the next choose $v_x^* = v_{xmin}^*$. The interval τ can be made equal to the sampling period (the smallest value) or multiple of the sampling period to reduce the average switching frequency. Once v_x^* is chosen, pole voltages v'_{e0} , v_{e0} , v'_{h0} , and v_{h0} are defined from (25) – (28). Since the pole voltages have been defined, pulse-widths τ_e , τ'_e , τ_h , and τ'_h can be calculated by

$$\tau_e = \frac{T}{2} + \frac{T}{v_c} v_{e0} \quad (31)$$

$$\tau'_e = \frac{T}{2} + \frac{T}{v_c} v'_{e0} \quad (32)$$

$$\tau_h = \frac{T}{2} + \frac{T}{v_c} v_{h0} \quad (33)$$

$$\tau'_h = \frac{T}{2} + \frac{T}{v_c} v'_{h0} \quad (34)$$

Alternatively, the gating signals can be generated by comparing the pole voltage with a high-frequency triangular carrier signal.

Method B: Local approach

In this case, the voltage v_{xs}^* is calculated by taking into account its maximum and minimum values in the series or shunt side. For example, if the series side is considered ($s=e$), then $v_{xemax}^* = \max \vartheta_e$ and $v_{xemin}^* = \min \vartheta_e$ with $\vartheta_e = \{v_e^*, 0\}$ and if the shunt side ($s=h$) is considered, then $v_{xhmax}^* = \max \vartheta_h$ and $v_{xhmin}^* = \min \vartheta_h$ with $\vartheta_h = \{v_e^*/2 + v_h^*/2 - v_0^*/2, v_e^*/2 - v_h^*/2 - v_0^*/2\}$. Besides these voltages, voltage v_x^* must also obey the other converter side. Then, these limits can be obtained directly from v_{xmax}^* and v_{xmin}^* from (3.35) and (3.36).

The algorithm for this case is given by

- 1) Choose the converter side to be the THD optimized and calculate v_{xs}^* between v_{xsmax}^* , v_{xsmmin}^* , or $v_{xsave}^* = (v_{xsmax}^* + v_{xsmmin}^*)/2$.
- 2) Calculate the limits v_{xmax}^* and v_{xmin}^* from (29) and (30).
- 3) Do $v_{xs}^* = v_{xmax}^*$ if $v_{xs}^* > v_{xmax}^*$ and $v_{xs}^* = v_{xmin}^*$ if $v_{xs}^* < v_{xmin}^*$.

4) Do $v_x^* = v_{xs}^*$.

5) Determine the pole voltage and the gating signal as in previous method.

OVERALL CONTROL SYSTEM

Fig. 2 presents the control block diagram of the system. The capacitor dc-link voltage v_c ($v_c = E$) is adjusted to a reference value by using the controller R_c , which is a fuzzy logic controller. This controller provides the amplitude of the reference current I_g^* . For the power factor and harmonic control, the instantaneous reference current i_g^* must be synchronized with voltage e_g . This is performed by the block GEN-g, from a phase-locked loop (PLL) scheme. From the synchronization with e_g and the amplitude I_g^* , the current i_g^* is generated. The current controller is implemented by using the controller indicated by block R_i which the input reference voltage v_h^* used to compose the PWM strategies for grid's current compensation.

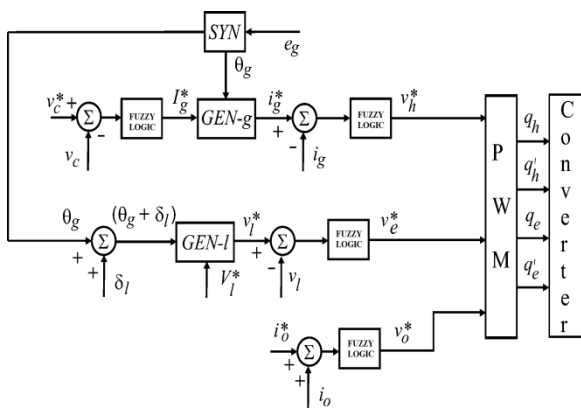

Fig. 2. Control block diagram with FLC

The instantaneous reference load voltage v_l^* can be determined by using the rated optimized load angle δ_l plus the information θ_g from block SYN and the defined load amplitude V_l^* . The block GEN-l uses the input information to generate the desired reference load voltage v_l^* . From the difference between the voltages v_l^* and v_l the block of control defined as R_e generates the reference voltage signal v_e^* to be applied to the PWM strategies in order to compensate for the load voltage. The homo-polar current i_o is controlled by controller R_o , that determines voltage v_o^* responsible to minimize the effect of the circulating current i_o , maintaining this current near to zero. The controllers are of type double-sequence digital controllers and all these reference voltages v_h^* , v_e^* , and v_o^* are applied to the PWM block to determine the conduction states of the converter's switches.

IV. FUZZY LOGIC CONTROLLER

In FLC, basic control action is determined by a set of linguistic rules. These rules are determined by the system. Since the numerical variables are converted into linguistic variables, mathematical modeling of the system is not required in FC. The FLC comprises of three parts: fuzzification, interference engine and defuzzification. The FC is characterized as i. seven fuzzy sets for each input and output. ii. Triangular membership functions for simplicity. iii. Fuzzification using continuous universe of discourse. iv. Implication using Mamdani's, 'min' operator. v. Defuzzification using the height method.

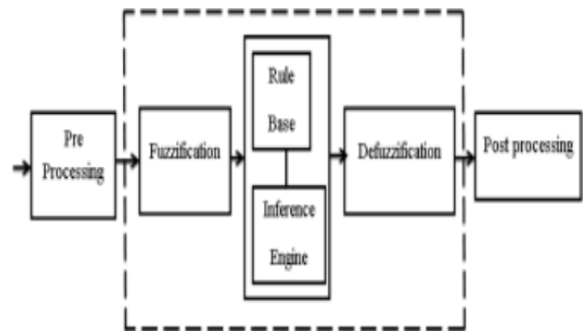

Fig.3. Fuzzy logic controller

Fuzzification: Membership function values are assigned to the linguistic variables, using seven fuzzy subsets: NB (Negative Big), NM (Negative Medium), NS (Negative Small), ZE (Zero), PS (Positive Small), PM (Positive Medium), and PB (Positive Big). The Partition of fuzzy subsets and the shape of membership $CE(k)$ $E(k)$ function adapt the shape up to appropriate system. The value of input error and change in error are normalized by an input scaling factor.

Table I Fuzzy Rules

Change in error	Error						
	NB	NM	NS	Z	PS	PM	PB
NB	PB	PB	PB	PM	PM	PS	Z
NM	PB	PB	PM	PM	PS	Z	Z
NS	PB	PM	PS	PS	Z	NM	NB
Z	PB	PM	PS	Z	NS	NM	NB
PS	PM	PS	Z	NS	NM	NB	NB
PM	PS	Z	NS	NM	NM	NB	NB
PB	Z	NS	NM	NM	NB	NB	NB

In this system the input scaling factor has been designed such that input values are between -1 and +1. The triangular shape of the membership function of this arrangement presumes that for any particular $E(k)$ input there is only one dominant fuzzy subset. The input error for the FLC is given as

$$E(k) = \frac{P_{ph(k)} - P_{ph(k-1)}}{V_{ph(k)} - V_{ph(k-1)}}$$

$$CE(k) = E(k) - E(k-1)$$

Inference Method: Several composition methods such as Max-Min and Max-Dot have been proposed in the literature. In this paper Min method is used. The output membership function of each rule is given by the minimum operator and maximum operator. Table 1 shows rule base of the FLC.

Defuzzification: As a plant usually requires a non-fuzzy value of control, a defuzzification stage is needed. To compute the output of the FLC, „height“ method is used and the FLC output modifies the control output. Further, the output of FLC controls the switch in the inverter. In UPQC, the active power, reactive power, terminal voltage of the line and capacitor voltage are required to be maintained. In order to control these parameters, they are sensed and compared with the reference values. To achieve this, the membership functions of FC are: error, change in error and output

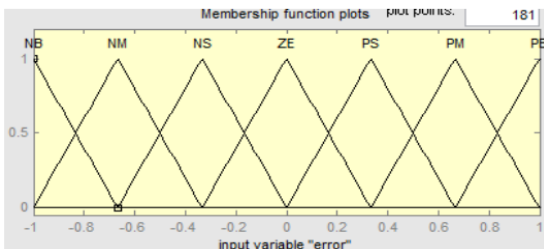

Fig.4. Membership functions

The set of FC rules are derived from

$$u = -[\alpha E + (1-\alpha) * C]$$

Where α is self-adjustable factor which can regulate the whole operation. E is the error of the system, C is the change in error and u is the control variable. A large value of error E indicates that given system is not in the balanced state. If the system is unbalanced, the controller should enlarge its control variables to balance the system as early as possible. On the other hand, small value of the error E indicates that the system is near to balanced state.

V. SIMULATION RESULTS

The proposed configuration was simulated using PSIM software with the following circuit parameters:

- 1) Power system: 1.2 kVA;
- 2) Source frequency of e_g : 60 Hz;
- 3) Harmonic frequency of e_g : 180 Hz;
- 4) DC-bus voltage, v_c : 130 Vdc and 250 Vdc;
- 5) Inductors filters, L_e and L_f : 7 mH;
- 6) Capacitor filter, C_e : 70 μ F;
- 7) Grid voltage, e_g : 110 Vrms \pm 20%;
- 8) Grid voltage, e_g : 50Vrms and 100 Vrms \pm 20%;
- 9) Load voltage, v_l : 50Vrms and 100 Vrms ;
- 10) Linear load composed by: $R = 5 \Omega$ and $L = 63$ mH.
- 11) Nonlinear load composed by diode bridge rectifier with: $R = 5\Omega$, $L = 75$ mH.

The proposed configuration does not use a transformer in the series connection and consist of four-leg converter. The capacitors of the dc-bus voltage and the switching frequency were, respectively, selected as $C = 2200 \mu$ F and 10 kHz. In order to demonstrate the feasibility of the proposed configuration, two different kinds of simulated results are presented.

MATLAB RESULTS

With fuzzy logic controller

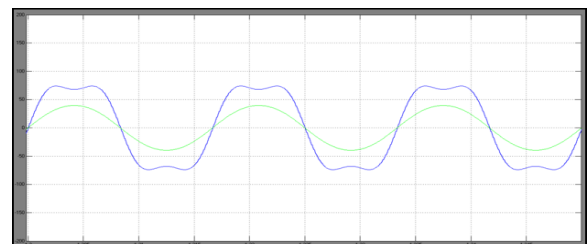

(a)

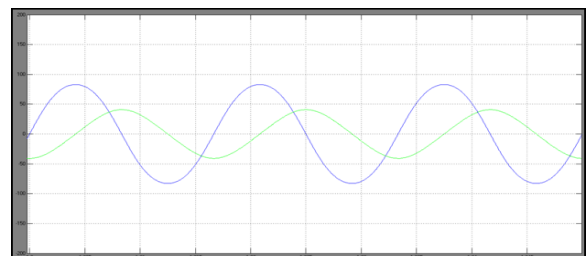

(b)

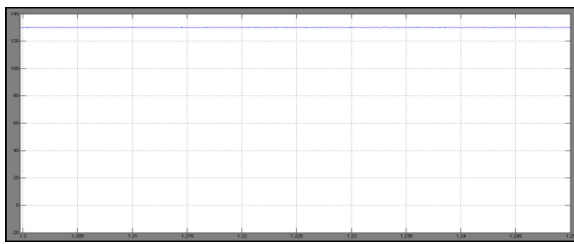

(c)

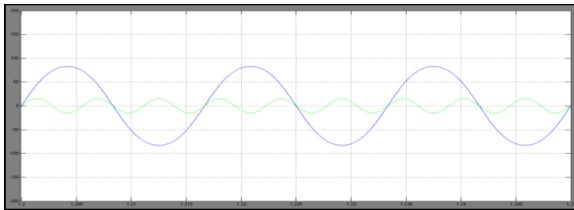

(d)

Fig. 9. Simulated results for a linear load: (a) voltage (e_g) and current (i_g) of the grid, (b) voltage (v_l) and current (i_l) of the load. (c) dc-bus voltage (v_c), (d) voltages v_{ce} and v_{ch}

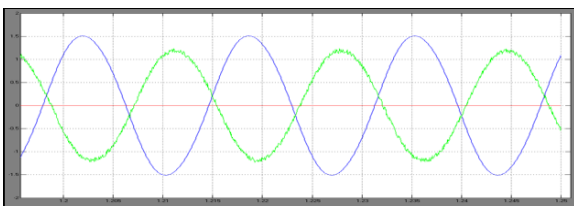

(a)

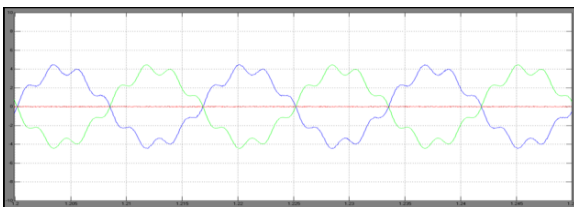

(b)

Fig. 10. Simulated results for a linear load: (a) currents of converter S_h (i_h and i'_h) and circulating current (i_0), (b) currents of converter S_e (i_e and i'_e) and circulating current (i_0)

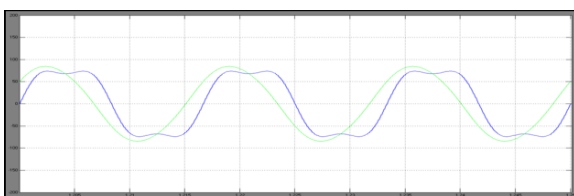

(a)

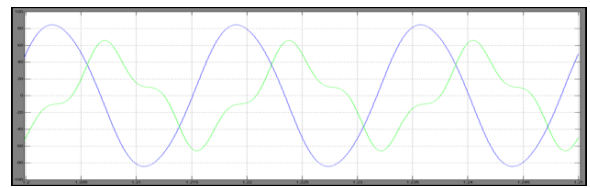

(b)

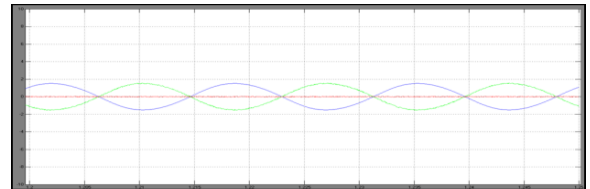

(c)

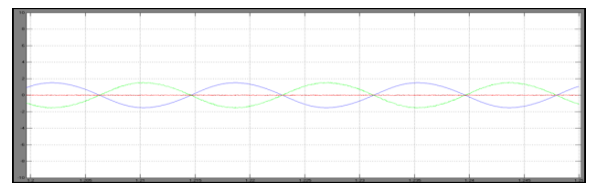

(d)

Fig. 11. Simulated results for a linear load with $\delta_l = -35^\circ$: (a) load (v_l) and grid (e_g) voltage, (b) voltages of the filters v_{ce} and v_{ch} , (c) currents of converter S_h (i_h and i'_h) and circulating current (i_0), (d) currents of converter S_e (i_e and i'_e) and circulating current (i_0)

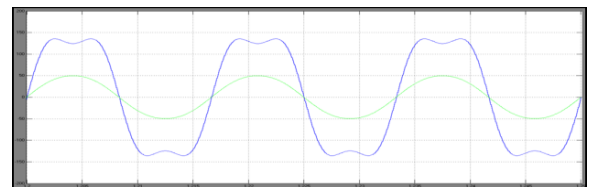

(a)

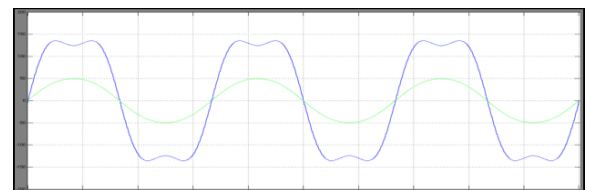

(b)

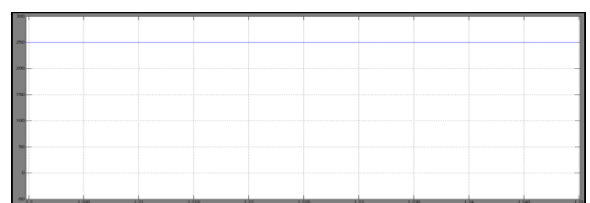

(c)

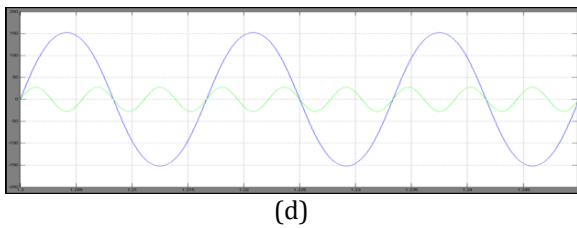

Fig. 12. Simulated results for a nonlinear load: (a) voltage (e_g) and current (i_g) of the grid, (b) voltage (v_l) and current (i_l) of the load. (c) dc-bus voltage (v_c), and (d) voltages v_{ce} and v_{ch}

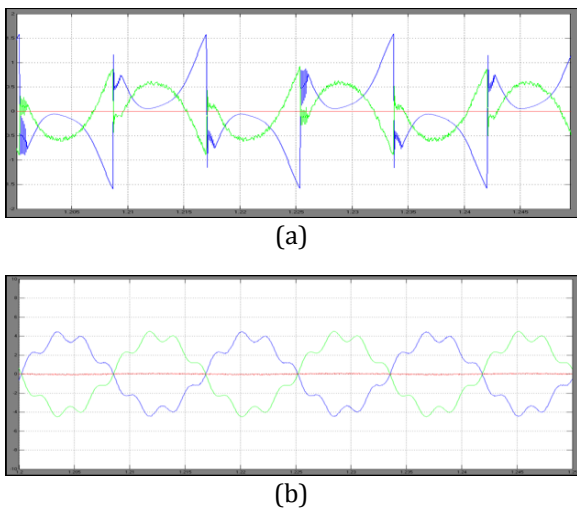

Fig. 13. Simulated results for a nonlinear load: (a) currents of converter S_h (i_h and i'_h) and circulating current (i_0); (b) currents of converter S_e (i_e and i'_e) and circulating current (i_0)

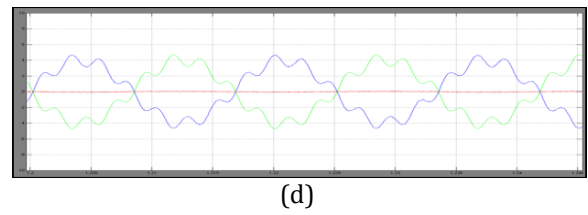
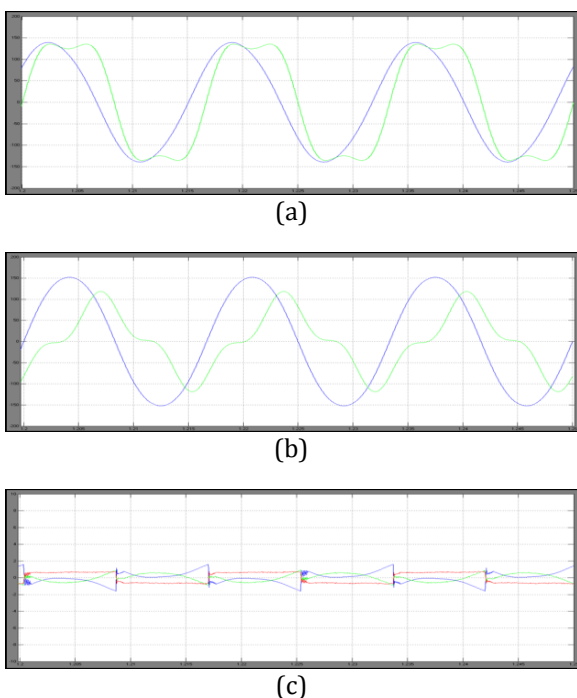

Fig. 14. Simulated results for a nonlinear load with $\delta_l = -35^\circ$: (a) load (v_l) and grid (e_g) voltage, (b) voltages of the filters capacitors v_{ce} and v_{ch} , (c) currents of converter S_h (i_h and i'_h) and circulating current (i_0), (d) currents of converter S_e (i_e and i'_e) and circulating current (i_0)

VI. CONCLUSION

A suitable control strategy, including the PWM technique has been developed for the proposed UAPF along with the fuzzy logic controller. In this way, it has been shown that the proposed configuration presents low WTHD, whose value is, however, higher than that of conventional configuration. Here we are using fuzzy logic controller instead of using other controller. The proposed transformer-less UAPF is controlled according to two proposed PWM techniques objecting the elimination of undesirable circulating current. The universal active power filter (UAPF) which is a combination of both, is a versatile device that operates as series and parallel active power filter. It can simultaneously full fill different objectives like maintaining a sinusoidal voltage (harmonic free) at the load, source current harmonics elimination, load balance, and power factor correction. So, by using fuzzy logic controller in UPFC model will improve reactive power injection and reduce THD content. The simulation was done by using MATLAB/ SIMULINK software.

REFERENCES

- [1] H. Akagi, "Trends in active power line conditioners," IEEE Trans. Power Electron., vol. 9, no. 3, pp. 263-268, May 1994.
- [2] B. Singh, K. Al-Haddad, and A. Chandra, "A review of active filters for power quality improvement," IEEE Trans. Ind. Electron., vol. 46, no. 5, pp. 960-971, Oct. 1999.
- [3] Z. Pan, F. Z. Peng, and S. Wang, "Power factor correction using a series active filter," IEEE Trans. Power Electron., vol. 20, no. 1, pp. 148-153, Jan. 2005.
- [4] S. Fukuda and T. Yoda, "A novel current-tracking method for active filters based on a sinusoidal internal model," IEEE Trans. Ind. Appl., vol. 37, no. 3, pp. 888-895, May/Jun. 2001.
- [5] H. Komurcugil and O. Kukrer, "A new control strategy for single-phase shunt active power filters using a lyapunov function," IEEE Trans. Ind. Electron., vol. 53, no. 1, pp. 305-312, Dec. 2006.

[6] L. Asiminoaei, F. Blaabjerg, and S. Hansen, "Detection is key - harmonic detection methods for active power filter applications," IEEE Ind. Appl. Mag., vol. 13, no. 4, pp. 22–33, Jul./Aug. 2007.

[7] J.-C. Wu and H.-L. Jou, "Simplified control method for the single-phase active power filter," IEE Proc Electr. Power Appl., vol. 143, no. 3, pp. 219– 224, May 1996.