

LATERAL STABILITY OF HIGH RISE STEEL BUILDINGS USING E TABS

TEJESH R, UMMER FAROOQ PASHA

¹PG student Dept. of Civil Engineering, Ghousia College of Engineering, Karnataka, India

²Associate Prof Dept. of Civil Engineering, Ghousia College of Engineering, Karnataka, India

Abstract - The present trend in construction industries is to build tall building i.e. vertical expansion due to scarcity of land available and increasing population. There are many areas of study in tall buildings such as p-delta effect, bracing axial contraction of columns, deep foundations etc. The cast of the building will increase as the height of the building increase due to increased weight of the building and increased forces. To reduce the cast and to increase the height of the building many researchers have proposed many methods one among them is composite construction (with concrete and steel structure). As the height of the building increases, lateral movement of the building also increases (sway). To reduce the sway one of the technique used is 'bracing'. There are many types of bracings normally used in the practice such as x-bracing, v-bracing, inverted v-bracing, eccentric bracing, k-bracing etc Also these bracing can be provided at different positions in the buildings. In the present study 15 storey steel structure of height 45m (3m each storey) was considered. The structure was designed as per IS 800:2007 code with dead load, live load earthquake load combinations and wind load combinations. Dynamic analysis (response spectra) was performed using E-tabs software assuming response reduction factor as 5, importance factor as 1, seismic zone II and type of soil is 2. The analysis was performed according to IS 1893. The analysis was performed for building without bracing, with X bracing and v-bracing. The Results were compared and studied. It was found that displacement of the structure was more in the structure without bracing than other models. It was also observed that lateral loads were more in the case of X-bracing. Finally it can be concluded that X-bracing is better for wind loading and V-bracing is better for earthquake loading, yet more studies is required to conclude further.

Steel construction is mainly frequently use in :

- High rise building since of its strong point low weight, and speed of construction.
- Industrial building since of its capability to make big width places at low cost
- Warehouse building for the similar cause
- Residential building in a method called light gauge steel construction.
- Temporary structure as these are rapid to set of connections and take away.

1.1 LATERAL LOADS:

High buildings be subjected to a variety of loads throughout its service life moment in time. It must be alive so designed to oppose the gravitational and lateral armed forces, both permanent and temporary, that will be call on to keep up during its structure and following service life. Major loads which tall building structure are subjected are given : Gravity load ♣ – Dead load & Live load Lateral load ♣ – Wind load, Seismic load. Special load ♣ – Impact load & Blast load.

1. INTRODUCTION

Structure is define as tall as it is significantly high than neighboring building or its quantity is lean sufficient to present the look of high buildings. The building of tall structure begin at closing stages of 19th century in Chicago, with development shown. This was made probable because of latest inventions such as the harmless elevator in 1853 and the phone in 1876 that enabled transfer of building material and the capability to commune to higher level. in adding up, the construction material altered as they go starting firewood and stonework to with steel frame by low stonework ramparts. Prior building that be build by weighty stonework wall was restricted to firm height by its individual self weight By means of steel frame the building material might be thinner and act barely like front for climate defense and high rise building might be construct.

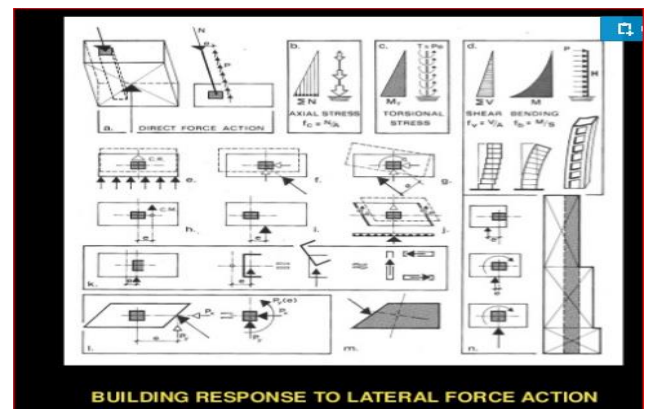

BRACING SYSTEM: The opposition to lateral loads from wind or an earthquake is cause for the progress of range of structural system. Bracing systems is one such structural method which form an vital element of framework. This construction had to be analyse prior to incoming at finest type, efficient understanding of bracing. This task is in relation to the effectiveness of with diverse type of bracing and by special brace profile pro bracings member for high rise steel frames. ETABS softwares is utilize for to reach the design of frame and bracings systems by the smallest amount heaviness plus suitable steel segment.

BRACING SECTIONS:

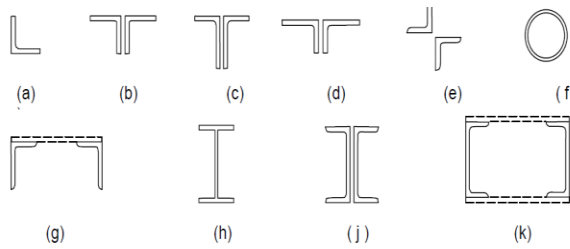

Type of Bracing:

There are two type of bracings system 1) Concentric Bracing System and 2) Eccentric Bracing System

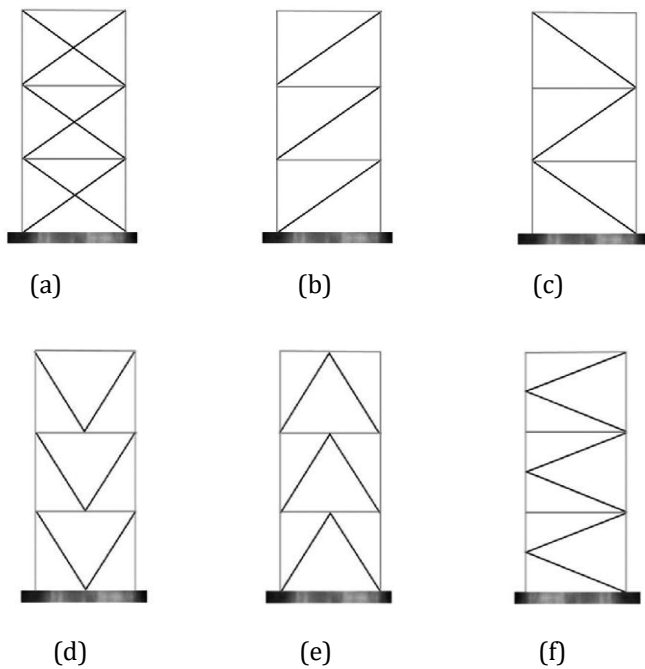

Fig-1-Example of bracings scheme to concentrically braced frame: (a) Xbraced;(b) diagonally braced; (c) alternative diagonally braced; (d) Vbraced;(e) inverted V-braced; and (f) K-braced

X-BRACED FRAME: An X-braced frame (Fig. 1(a)) had bracings member in tension to equally direction of loadings, if these be size to succumb previous to column otherwise beam fall short, ductility could developed. These usually design assume that compression brace do not donate rigidity otherwise force

DIAGONAL BRACES: Single bay of diagonal brace (Fig. 1(b) and (c)) react to path of loadings. Configuration (b) possibly greatly weak with elastic in path cause compressions in brace, as configurations (c) will be weak as well as extra elastic in storey with compression brace, most important to risk of soft-storey formations. This is plainly not suitable. by extra one diagonal brace bay, act could lapse to that of X-bracings if appropriate collection of bracings directions is selected.

V-BRACINGS: The V-braced provision of Fig. 1(d) and (e) experience as of truth that buckling's ability of compression braces is possible elect considerably fewer than tensions give up capability of tension braces. so here is unavoidably out of equilibrium loads on horizontal beams when their ability, which must be resist in bendings of level part These restrict quantity of elastic that brace could build up ,and hence taken as a whole ductility. Where horizontal braces has great bending strength that could oppose out of equilibrium loads, hysteretic presentation of V- braced system is enhanced.

K-BRACES: The similar out of balance strength apply to K-brace (Fig. 1(f)) when brace arrive at their capability, but this instance it's greatly extra power functional to columns – risky since columns collapse could cause broad fail pro this cause K-braces not allowed in seismic region.

Below mentioned models are considered for analysis an designs as per Limit State Design.1.) Without Brace model 2.) X- brace model 3.)V -brace model.

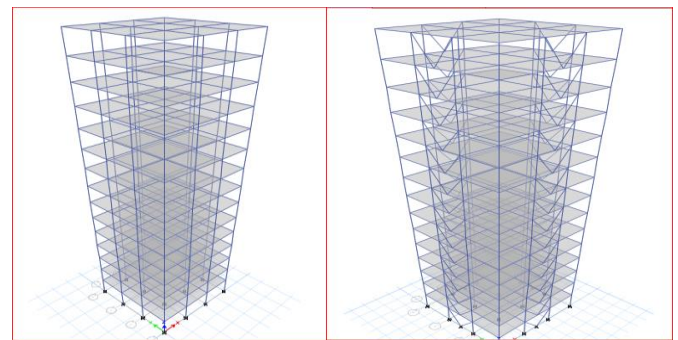

MODEL (WITHOUT BRACING) V-BRACED MODEL

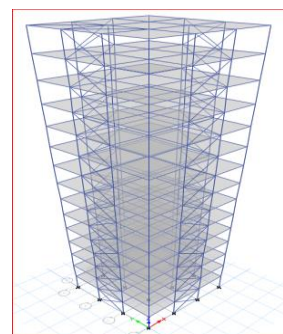

X-BRACED MODEL

OBJECTIVES OF STUDY: The objectives of this work are

- 1)To study and understand the different lateral forces that acts on steel structure.
- 2)To analyse the steel structure by dynamic response spectrum method by using E-TABS for different load combination
- 3)To apply different types of bracings to increases lateral stability.
- 4)Compare the steel structure behavior to lateral forces with and without bracings i.e To compare the time period, storey displacement, story drifts, and storey shear of steel structure with and without bracings for different load combinations.

METHODOLOGY:

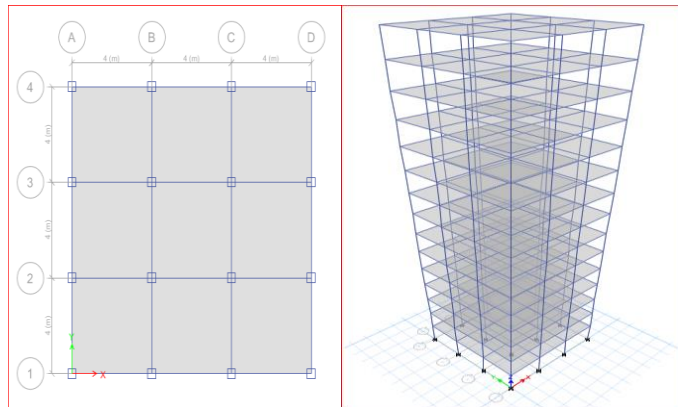

Plan of the structure

3d view of frame structure

E-TABS

The present study is to study the lateral stability of high rise steel building comprising of beam, column. The study include of greatest lateral drift, base shear, time period, and story displacement generated in the frames for seismic zones III in India. For these cases, models has been created for steel framed building, analyzed with ETABS for seismic zones. This study also focused on applying different types of bracing system to structure to increase lateral stability of the structure and analysed with software E-TABS.

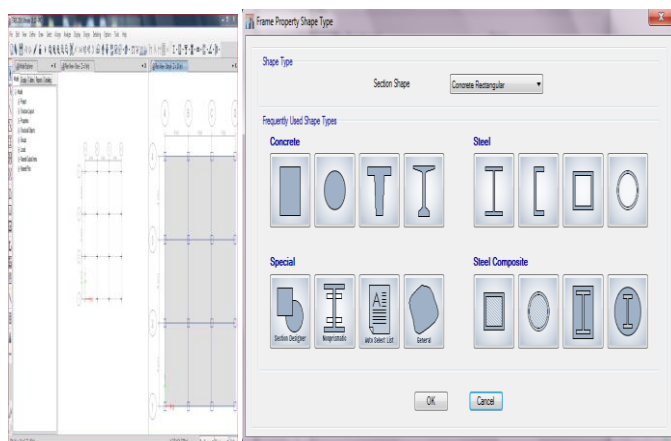

MODELLING AND SECTION PROPERTIES

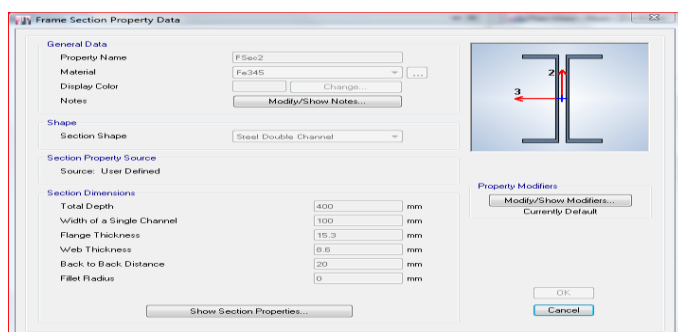

MATERIALS:

Size of the building	12m X 12m
Type of structure	Steel frame structure
No of storeys	15
Height of each floor	3m
Height of the building	45m
Depth of beam	ISMB 600
Depth of column	400X400X13mm(thick)BOX SECTION
No of modes considered	12
Depth of foundation	1.5m(it is not in scope)
Dead load	Self assigned by E-tabs(member weights)
Concrete	M20
Unit weight of RCC	25
Imposed load	4Kn/m2
Steel	Fe345
Diaphragms considered	Semi rigid
Considered loads for earthquake analysis	D.L+SIDL+0.5L.L(since live load is greater than 3kn/m2)
Total thickness of slab	100mm (designed as composite deck slab)(out of scope of this study)
Supports considered at base	fixed

Seismic zone	II
Response reduction factor	5
Importance factor	1
Response spectra	According to IS1893
Damping	0.05
Type of soil	2

RESULTS:

- ✚ LOAD COMBINATIONS:
- ✚ Analysis is performed for all load combinations as per IS code, Considered earthquake for the study.
- ✚ Wind load combination considered: 1.2DL+1.2LL+1.2SIDL+1.2WINDY
- ✚ Response spectrum combination considered- 1.2DL+1.2LL+1.2SIDL+1.2RY

MAXIMUM STOREY DISPLACEMENT

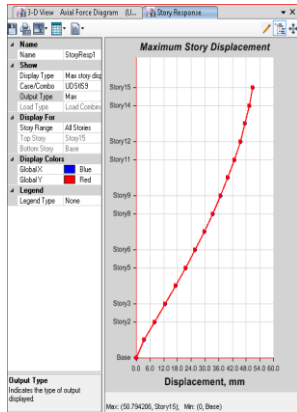

Story	Elevation	Location	X-Dir	Y-Dir	X-Dir Min	Y-Dir Min
	m		mm	mm	mm	mm
Story15	45	Top	50.8	50.8	0.01498	0.01498
Story14	42	Top	49.3	49.3	0.004638	0.004638
Story13	39	Top	47.5	47.5	0.00176	0.00176
Story12	36	Top	45.4	45.4	0.001919	0.001919
Story11	33	Top	42.9	42.9	0.001898	0.001898
Story10	30	Top	40	40	0.001893	0.001893
Story9	27	Top	36.9	36.9	0.001875	0.001875
Story8	24	Top	33.4	33.4	0.001856	0.001856
Story7	21	Top	29.7	29.7	0.00184	0.00184
Story6	18	Top	25.7	25.7	0.001826	0.001826
Story5	15	Top	21.5	21.5	0.001862	0.001862
Story4	12	Top	17.2	17.2	0.001935	0.001935
Story3	9	Top	12.7	12.7	0.002084	0.002084
Story2	6	Top	8	8	0.002055	0.002055
Story1	3	Top	3.4	3.4	0.005383	0.005383
Base	0	Top	0	0	0	0

MODAL PARTICIPATING MASS RATIOS

Case	Mode	Period	UX	UY	UZ	Sum UX	Sum UY	Sum UZ
		sec						
Modal	1	1.525	0.7825	0	0	0.7825	0	0
Modal	2	1.525	0	0.7825	0	0.7825	0.7825	0
Modal	3	1.312	0	0	0	0.7825	0.7825	0
Modal	4	0.489	0.1269	0	0	0.9094	0.7825	0
Modal	5	0.489	0	0.1269	0	0.9094	0.9094	0
Modal	6	0.435	0	0	0	0.9094	0.9094	0
Modal	7	0.271	0.0365	0	0	0.9459	0.9094	0
Modal	8	0.271	0	0.0365	0	0.9459	0.9459	0
Modal	9	0.259	0	0	0	0.9459	0.9459	0
Modal	10	0.19	0.0185	0	0	0.9644	0.9459	0
Modal	11	0.19	0	0.0185	0	0.9644	0.9644	0
Modal	12	0.183	0	0	0	0.9644	0.9644	0

STOREYSHEARS

Story	Elevation	Location	X-Dir	Y-Dir	X-Dir Min	Y-Dir Min
	m		kN	kN	kN	kN
Story15	45	Top	0	0	-54.2599	-54.2599
		Bottom	0	0	-54.2599	-54.2599
Story14	42	Top	0	0	-161.8267	-161.8267
		Bottom	0	0	-161.8267	-161.8267
Story13	39	Top	0	0	-267.9704	-267.9704
		Bottom	0	0	-267.9704	-267.9704
Story12	36	Top	0	0	-372.7005	-372.7005
		Bottom	0	0	-372.7005	-372.7005
Story11	33	Top	0	0	-476.0264	-476.0264

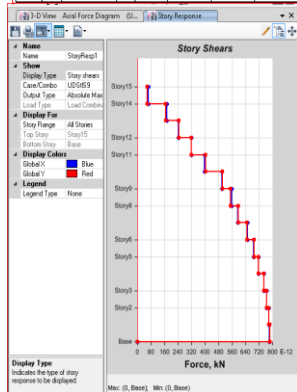

Story	Elevation	Location	X-Dir	Y-Dir	X-Dir Min	Y-Dir Min
	m		kN	kN	kN	kN
Story15	45	Top	0	0	1045.3299	1045.3299
		Bottom	0	0	-1128.93	-1128.93
Story14	42	Top	0	0	-1128.93	-1128.93
		Bottom	0	0	-1128.93	-1128.93
Story13	39	Top	0	0	1210.0307	1210.0307
		Bottom	0	0	1210.0307	1210.0307
Story12	36	Top	0	0	1290.9348	1290.9348
		Bottom	0	0	1290.9348	1290.9348
Story11	33	Top	0	0	1371.8389	1371.8389
		Bottom	0	0	1371.8389	1371.8389
Base	0	Top	0	0	0	0
		Bottom	0	0	0	0

From above table it is evident that all the modals are participating in the analysis that is 100%. As per the code minimum 90% modals have to be participated therefore we achieved 100% Mass participation

TIME PERIOD AND FREQUENCIES

Case	Mode	Period	Frequency	Circular Frequency	Eigenvalue
		sec	cyc/sec	rad/sec	rad ² /sec ²
Modal	1	1.525	0.656	4.1209	16.9815
Modal	2	1.525	0.656	4.1209	16.9815
Modal	3	1.312	0.762	4.7902	22.946
Modal	4	0.489	2.045	12.8508	165.1422
Modal	5	0.489	2.045	12.8508	165.1426
Modal	6	0.435	2.298	14.4383	208.4656
Modal	7	0.271	3.686	23.1605	536.4071
Modal	8	0.271	3.686	23.1605	536.4085
Modal	9	0.259	3.866	24.2879	589.8997

It is observed from above table that time period of first mode is observed to be 1.525sec with frequency of 0.656 cyc/sec

INTERSTOREY DRIFTS

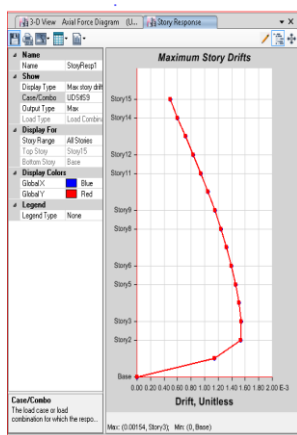

Story	Elevation	Location	X-Dir	Y-Dir
	m			
Story15	45	Top	0.000495	0.000495
Story14	42	Top	0.0006	0.0006
Story13	39	Top	0.000717	0.000717
Story12	36	Top	0.000833	0.000833
Story11	33	Top	0.000945	0.000945
Story10	30	Top	0.001051	0.001051
Story9	27	Top	0.00115	0.00115
Story8	24	Top	0.001242	0.001242
Story7	21	Top	0.001324	0.001324
Story6	18	Top	0.001397	0.001397
Story5	15	Top	0.001458	0.001458
Story4	12	Top	0.001506	0.001506
Story3	9	Top	0.00154	0.00154
Story2	6	Top	0.001535	0.001535
Story1	3	Top	0.001144	0.001144

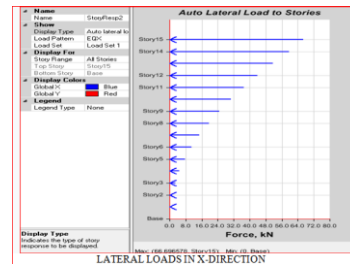

Story	Elevation	Location	X-Dir	Y-Dir
	m		kN	kN
Story15	45	Top	66.6966	0
Story14	42	Top	59.8374	0
Story13	39	Top	51.5945	0
Story12	36	Top	43.9622	0
Story11	33	Top	36.9404	0
Story10	30	Top	30.5293	0
Story9	27	Top	24.7287	0
Story8	24	Top	19.5387	0
Story7	21	Top	14.9593	0

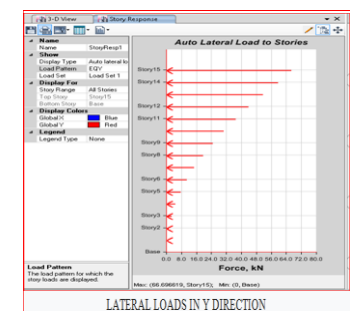

Story	Elevation	Location	X-Dir	Y-Dir
	m		kN	kN
Story15	45	Top	0	66.6966
Story14	42	Top	0	59.8374
Story13	39	Top	0	51.5945
Story12	36	Top	0	43.9622
Story11	33	Top	0	36.9405
Story10	30	Top	0	30.5293
Story9	27	Top	0	24.7287

CONCLUSION

1.Displacement of structure without bracing is more than that of with bracing by approximately 31 percent (in wind load combination).

2.Displacement of structure without bracing is more than that of with bracing by approximately 39 percent (in response spectra load combination).

3.Least bracing in wind load combination and response spectra combination is observed in structure with X-bracing and V- bracing respectively.

4.Minimum time period was observed for X-bracing in both the cases.

5.Lateral loads are observed to be more in the structure with X-bracing since weight of the structure is more in this case.

6.Displacements in wind load combination are more than response spectra combination, from which we can conclude that steel structures are more critical for wind loads.

7.From above tables we can say that structure with X-bracing is better for wind loading and V-bracing is better for earthquake loading, yet more studies has to be conducted for better understanding of bracings in different situations.

FUTURE SCOPE:

Above study was done for only 3 types of bracing namely X-bracing, V-bracing .Therefore following study can be done in future.

(1) to find the response of structure for other types of bracings.

(2)To find the response of structure with bracing at inside of the building.

(3)To find the response of structure by using combination of bracings

(4)To find the response of structure with irregularities.

REFERENCES:

- IS: 456-2000, Plain and reinforced concrete - Code of practice, Bureau of Indian Standards, New Delhi.
- IS: 1893 (Part 1); 2002, Indian Standard: Criteria for Earthquake Resistance Design of Structures, New Delhi, India.
- Agarwal.P and Shrikhande.M,“Earthquake Resistant Design of Structures”, Prentice Hall of India Pvt. Ltd., India, (2014),
- Kalyan chowdary kodli[2015]“Comparative study of seismic performance of high rise 30 story building

with beam slab, flat slab and alternate flat beam slab systems in zone V”.

- Ashish mohan shivhare[2014] “seismic analysis of parametric tall buildings with different geometry and constant plan area”.
- K.g.patwari, l.g, kalurkar [2016] “Comparative study of RC flat slab & conventional framed structure in high rise building”.
- Rajini .A .T “ Behaviour of Steel Structural System under Seismic Loading”.
- Prof. K S Sable “Comparative study of seismic behavior of multistory steel structure and Conventional reinforced concrete framed structures”.
- K. Nageswarao “Seismic behavior of Reinforced Concrete Framed Structure and Conventional Floor Slab System”.