

# Wireless Communication Improvement using Lasers: A Comprehensive Study on Laser Communicator

Sachin Choudhary<sup>1</sup>, Shailesh Kumar Singh<sup>2</sup>

<sup>1</sup>M.Sc. Student, Monad University, Ghaziabad, India

<sup>2</sup>Professor, Monad University, Ghaziabad, India

\*\*\*

**Abstract:** Since the beginning of wireless communication it has gained widespread popularity and acceptance in the world. It provides a setup which uses minimum amount of cables for data transmission. There has been associate degree explosive growth within the wireless communications over the previous few decades in its applications cellular telecommunication, wireless web and wireless home networking arenas. As we've got advanced therefore has the information processed and transmitted has exaggerated exponentially resulting in massive information issues. The wireless media is currently changing into less economical in handling giant amounts of knowledge signalling to a brand new innovation in communications. This paper is meant to produce the reader with an summary of innovation that has been earned with the assistance of lasers to transmit sound and conjointly elaborates on however it's being employed alongside the longer term developments.

**Keywords:** Laser power transmission, Receiver, Transmitter, Wireless Network

## I. Introduction

In 1864 James Clerk Maxwell proved the existence of electromagnetic waves [14] and after deep research and development, the ability to communicate by using electromagnetic waves was developed and now has been deeply integrated into many aspects. The advantages of optical communication, as compared with frequency (RF) communication, is to achieve a wider information measure, a bigger transfer capability, and lower power consumption, and a lot of compact instrumentation, bigger security against eavesdropping and protection against interference. because the demand for prime knowledge transmission rates from space-borne plat however as we've got advanced we have a tendency to area unit starting to see the issues of wireless networks that area unit as follows:

## 2 History of laser-based space communication

### 2.1 Research on laser beam propagation to satellites

Extensive research on the theory of laser propagation in the presence of atmospheric turbulence has been conducted since the 1970s [9,10]. The first theoretical study on scintillation for an uplink laser transmission to a satellite was performed by Fried in 1967 [11]. Several years later, Minott discussed experimental data obtained in 1968 from a continuous-wave (CW) argon laser illuminating the Geodetic Earth Orbiting Satellite II (GEOS-II) [12]. In 1973, in a study similar to that conducted by Fried, Titterton examined focused and defocused beams and concluded that on-axis scintillation can be reduced even further with a focused beam [13][14]. Fried also considered the effect of pointing jitter on the probability distribution for the strength of the received signal and showed that the log intensity takes the particularly simple form of an exponential distribution [15]. Measurements of scintillation on a vertical path from a ground-based laser transmitter to the GEOS-III satellite and back to the transmitter were reported by Bufton in 1977 and compared with the theoretical model.

In 1983, Yura and McKinley published a theoretical study on fades and surges for a ground-to-space link in which the transmitted wave is a spherical wave operating in the 1–10  $\mu\text{m}$  wavelength regime [17]. In the Relay Mirror Experiment (RME) conducted by the Strategic Defense Initiative Organization (SDIO) in the early 1990s, three laser beams were projected from two ground sites at the Air Force Maui Optical Station (AMOS) in Hawaii, US. These beams were both retroreflected and reflected from the RME satellite orbiting at an altitude of 350 km. The uplink beam intensity profile at the satellite appeared as a moderately distorted form of an idealized Gaussian beam profile [18]. In 1994, Kiasaleh derived expressions for the probability density function (PDF) of the optical signal intensity in an optical communication channel and investigated the impact of the residual pointing error caused by imperfect tracking for various channel scattering models as a result of the Galileo Optical Experiment (GOPEX) [19]. In 1995, Shelton published expressions describing the variance and the power spectral density of turbulence-induced log-amplitude fluctuations associated with an uplink Gaussian beam wave with the Low-Power Atmospheric Compensation Experiment (LACE) satellite developed by the US Naval Research Laboratory [20]. In 1995, Andrews et al. derived estimates for the beam spot size, scintillation index, fractional fade time, expected number of fades and mean duration of the fade time associated with both the uplink

and the downlink propagation channels for a laser satellite communication system [21]. In 2000, Andrews et al. extended their scintillation model for a satellite communication link from the moderate- to the strong-turbulence regime. This scintillation model was derived as a modulation process in which the small-scale (diffractive) fluctuation was multiplicatively modulated by the large-scale (refractive) fluctuation. The results agreed well with the conventional weak scintillation theory for zenith angles of less than 45-60°. The PDF for the moderate-to-strong-turbulence regime was described sufficiently well by the gamma-gamma distribution, which was also in close agreement with simulation data [22] [24].

## 2.2 Laser beam transmission experiments at NICT

NICT has been researching horizontal laser beam propagation since the 1970s [25] [26]. An experiment on laser beam transmission from the ground to the Engineering Test Satellite III (ETS-III) was conducted by using a camera onboard the satellite [27], followed by an experiment on laser transmission to Geostationary Meteorological Satellite (GMS) at wavelengths of 0.5  $\mu\text{m}$  and 10.6  $\mu\text{m}$  [28] [29]. Another experiment focused on position correction using the uplink laser beam transmission with the Marine Observation Satellite-1b (MOS-1b) [30]. In 1989, the space optical communication ground station was developed [31], and the satellite laser ranging (SLR) experiment was performed with geodesic satellites (Ajisai, LAGEOS). An experiment involving SLR to the Retro-reflector In-Space (RIS) onboard the ADEOS satellite was conducted by using a CO<sub>2</sub> laser radar, and a similar experiment was conducted by using the Laser Reflecting Equipment (LRE) onboard a H-II A launch vehicle [34] [35]. Between 1994 and 1996, the first ground-to-geostationary satellite laser communication experiments were successfully conducted by using the Laser Communication Equipment (LCE) onboard the Engineering Test Satellite VI (ETS-VI) [36] [37]. In 2004, an experiment on laser transmission to a CMOS camera onboard the Microlab-sat 1 ( $\mu$ -LabSat) was successfully performed [38] [39]. After the KODEN experiment, NICT is currently planning in-orbit laser communication experiments with 50-kg class microsatellites [40], and it is important to verify the tracking and pointing performance of the NICT optical ground station by using LEO satellites.

## 2.3 First ground-to-LEO laser communication experiment

In Japan, NICT with success performed the primary two-way optical device communication demonstration communication. The optical device communication equipment aboard the ETS-VI satellite in Geosynchronous Earth Orbit (GEO) [36], and a ground-to-ARTEMIS optical communication experiment victimisation the Semiconductor Intersatellite optical device Experiment (SILEX) optical terminal was with success conducted in collaboration with the ESA optical ground station in Tenerife, Spain [41]. However, with low earth orbit (LEO) satellites, exploit and following the counter terminal is especially troublesome because of the high angular rate of such satellites. within the Relay Mirror Experiment (RME) within the early Nineties, 3 optical device beams were projected from 2 ground sites in Hawaii. These beams were each retroreflected and mirrored from the RME satellite orbiting at 350 kilometre. The transmission beam intensity profile was measured, however, there was no optical device communication experiment [18]. moreover, the Ballistic Missile Defense Organization (BMDO) developed optical device communication terminal instrumentality for the authority area Technology analysis Vehicle two experiment. Unfortunately, the experiment led to failure in 2000 because of an oversized perspective error within the host satellite [42]. Therefore, to our data, KODEN was the primary in-orbit optical communication demonstration employing a LEO satellite.

## NICT optical ground station system

### 4.1 Configuration of NICT optical ground station

The fidelity of free-space optical device communication between ground and satellite optical systems is degraded by the turbulent atmosphere of Earth. attainable techniques for compensating for the consequences of scintillation include the employment multibeam optical device transmission [44] and reconciling optical systems [45]. However, reconciling optical systems cannot be simply applied to a link between a ground-based station associated an LEO satellite thanks to the point-ahead angle. For this reason, the NICT optical ground station uses a multi-beam optical device transmission system for the transmission, wherever optical device beams are shaped with completely different incoherent laser supplies or identical optical device supply is split into multiple beams with acceptable optical delays that correspond to the coherence length of the optical device source [46]. A 1.5-m telescope is employed for transmission, and therefore the sub-aperture of the one.5-m telescope is employed for downlink reception.

### 4.2 Transmitter

Figure two shows a diagram of the la-ser transmitter at the bottom station. 2 optical device sources were employed in the experiment, namely, a beacon beam with a broad divergence angle and a communication beam with a slim di-vergence angle. The optical parts for the beacon beam were mounted beside the one.5-m telescope tube. The divergence angle of the only transmission beacon beam during this system was nine mrad, and its wavelength was 808 nm. This divergence angle was capable of covering the open inform error of the optical ground sta-tion because of the prediction error of the satellite orbit. The beacon beam was fed into a multi-mode fiber with a core diameter of four hundred  $\mu\text{m}$ , with a most power of thirty W, once that it absolutely was transmitted as shown in Fig. 3. Figures four and five show the beam profile and also the section of the beacon light beam, severally. The section error was zero.150  $\lambda$  (rms).

The optical parts for the communica-tion beam were placed on a coude bench as shown in Fig. 6. The communication beam was transmitted from the optical device supply through the coude optical path and out the one.5-m tele-scope by exploitation open inform management. A semi-conductor light beam with a wavelength of 815 nm and a most modulated output.



The 1.5-m telescope, the beacon laser source and the beacon aperture

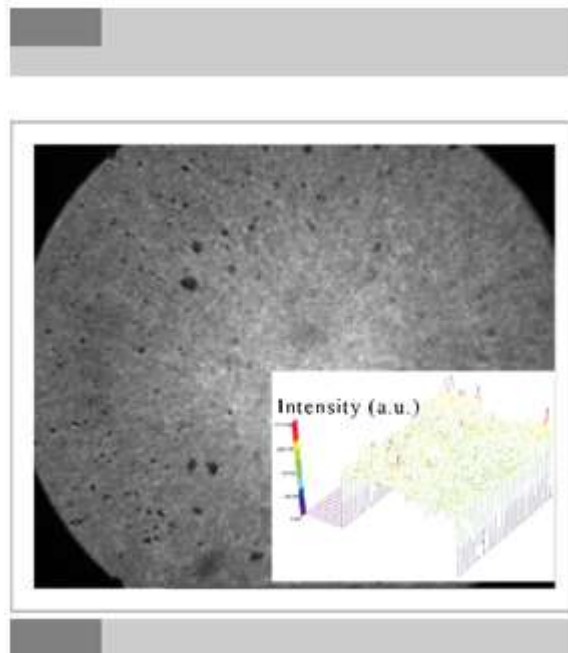

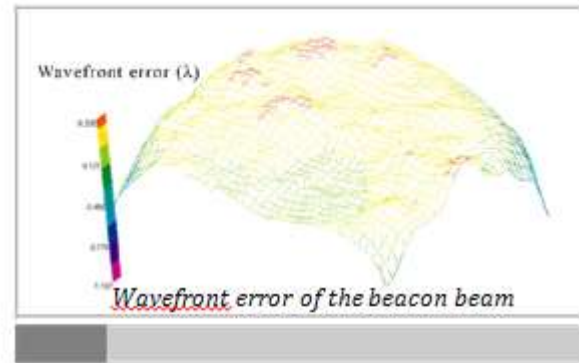
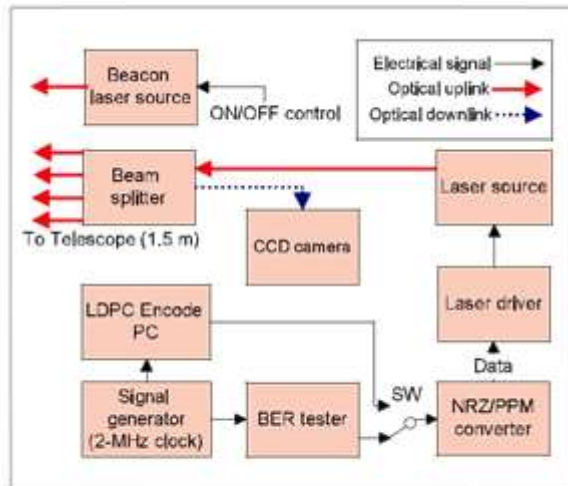

*Configuration of the transmitter Intensity profile of the beacon beam*

### 1.1 Signal fading

Unlike wired media, signals transmitted over a wireless medium could also be distorted or weakened as a result of they're propagated over AN open, unprotected, and ever dynamical medium with irregular boundary. Besides, an equivalent signal could disperse and travel on totally different methods thanks to reflection, optical phenomenon, and scattering caused by obstacles before it arrives at the receiver. The spread signals on {different|totally totally different|completely different} methods could take different times to achieve the destination. Thus, the resultant signal once summation all spread signals could be considerably distorted and attenuated when put next with the transmitted signal. The receiver might not acknowledge the signal and thence the transmitted knowledge can't be received. This unreliable nature of the wireless medium causes a considerable variety of packet losses.[1]

### 1.2. Mobility

Without the constraints imposed by the wired connections among devices, all devices in a wireless network are free to move. To support mobility, an ongoing connection should be kept alive as a user roams around. In an infrastructure network, a handoff occurs when a mobile host moves from the coverage of a base station or access point to that of another one. A protocol is therefore required to ensure seamless transition during a handoff. This includes deciding when a handoff should occur and how data is routed during the handoff process. In some occasions, packets are lost during a handoff. In an ad hoc network, the topology changes when a mobile host moves. This means that, for an ongoing data communication, the transmission route may need to be recomputed to, cater for the topological changes. Since an ad hoc network may consist of a large number of mobile hosts, this imposes a significant challenge on the design of an effective and efficient routing protocol that can work well in an environment with frequent topological changes.[1]

### 1.3. Power and energy

A mobile device is generally handy, small in size, and dedicated to perform a certain set of functions; its power source may not be able to deliver power as much as the one installed in a fixed device. When a device is allowed to move freely, it would generally be hard to receive a continuous supply of power. To conserve energy, a mobile device should be able to operate in an effective and efficient manner. To be specific, it should be able to transmit and receive in an intelligent manner so as to minimize the number of transmissions and receptions for certain communication operations. [1][3]

### 1.4. Data Rate

Improving the current data rates to support future high speed applications is essential, especially, if multimedia service are to be provided. Data rate is a function of various factors such as the data compression algorithm, interference mitigation through error-resilient coding, power control, and the data transfer protocol. Therefore, it is imperative that manufacturers implement a well thought out design that considers these factors in order to achieve higher data rates. Data compression plays a major role when multimedia applications are to be supported.[1]

## 1.5. Security

Mobility of users increases the security concerns in a wireless network [4]. Current wireless networks employ authentication and data encryption techniques on the air interface to provide security to its users. The IEEE 801.11 standard [5] describes wired equivalent privacy (WEP) that defines a method to authenticate users and encrypt data between the PC card and the wireless LAN access point.[1]

## 1.6. Quality of Service (QoS)

Quality of Service is a measure of network performance that reflects the network's transmission quality and service availability. For each flow of network traffic, QoS can be characterized by four parameters

## II. Sound transfer using LASER (Laser Communicator)

### 2.1 Objective

- Transmission of sound using laser light as the carrier which is accomplished by a transmitter.
- Reception of the signal at the receiver and then conversion to the original signal.

### 2.2 HARDWARE COMPONENTS REQUIRED

- Transmitter
- Receiver

#### 2.2.1 for Transmitter.

- A laser (in this assignment, red is chosen, 5mW, 650nm, class III A pen laser)
- 3 AA batteries 1.5 volts each along with holder (4.5 volts total)
- An audio output transformer/sound output transformer (1K $\Omega$  - 8  $\Omega$ )/optional
- Clip leads
- Aux cable with striped ends
- Sound source(mike/ radio/ phone)

#### 2.2.2 for Receiver.

- Solar panel (1 watt)
- Clip leads
- Amplifier(radio with aux in)/ a speaker along with aux jointer



**Figure 1:** Components required for sound transfer using laser

### 2.3 Arrangement of hardware at transmitter side

Remove the cells of the battery and run the clip leads between the battery, transformer, aux cable and the laser as shown in the circuit diagram.

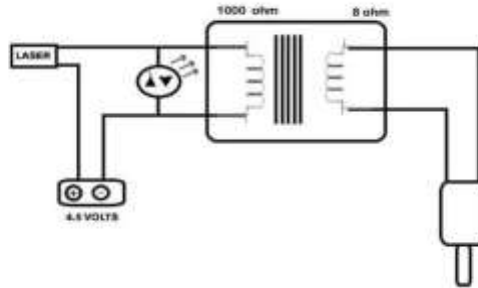

If the transformer is not available, then connect the laser, batteries and the aux cable without the transformer. When the batteries are removed a spring can be seen, this is the negative end, connect this end to the negative terminal of the battery and connect the positive end of the battery to the body of the laser through jumpers. If a 3 cell holder is not available then you can modify either 2 two cell holders or a 4 cell holder.

### 2.4 Arrangement of hardware at receiver side

The solar panel is connected to an aux cable which will be connected to an amplifier (radio) as shown in the circuit diagram. The receiver can also be connected to a speaker via aux jointer.

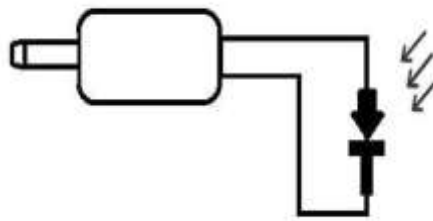

Figure 3. Receiver

The negative end of the solar panel is connected to the negative end of the aux i.e. the wire which is connected to the tip of the aux connector of the cable.

### 2.5 Working of Laser Communicator

After making connections through the jumpers first test the transmitter by checking whether the laser is working a multimeter can be used to check all the connections. Similarly check the receiver with the help of multimeter. It will show the reading of the voltage output of the solar panel. The laser used gives a change of 0.2 volts when directed towards the solar panel.

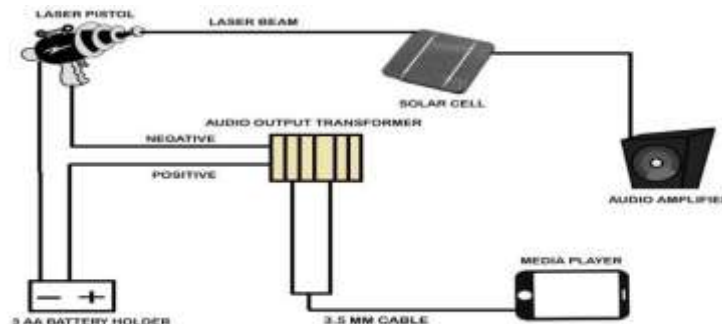

Figure 4. Simple Laser Communication

The sound source is taken to be the music played on a mobile device (any other device such as a radio can also be used). When the song is played it travels as electrical signal to the audio output transformer via the aux cable. The audio output transformer amplifies the electrical signals and then delivers it to laser. The sound is then transmitted in the form of light.

## 2.6 Performance

This technique will give data rates of 622 Mbps (as tested by NASA).[15] The upload speed will be of 20Mbps (as tested by NASA).[15] The performance is directly proportional to the intensity of the laser and inversely proportional to the distance between the sender and receiver. The weather play a very vital role, this technique works best in clear conditions

## 2.7 Advantages

With this new technique we can transmit any kind of data much faster safer and at very high transfer rates which are out of reach of the R.F. spectrum. As compared to R.F. devices the circuitry used is very less and will take very less space. It is the next generation which will take over fibre optics, R.F. transmission. Its best use will be in space missions and defence.

## III. Laser Applications in different fields

### 3.1 Military

#### 3.1.1 In Laser Range Finder

To knock down an enemy tank, it is necessary to range it very accurately. Because of its high intensity and very low divergence even after travelling quite a few km, laser is ideally suited for this purpose. The laser range finders using neodymium and CO<sub>2</sub> lasers have become a standard item for artillery and tanks. These laser range finders are light weight and have higher reliability and superior range accuracy as compared to the conventional range finders. The laser range finder works on the principle of radar. It makes use of the characteristic properties of the laser beam, namely, monochromaticity, high intensity, coherency, and directionality.

The laser range finder is superior to microwave radar as the former provides better collimation or directivity which makes high angular resolution possible. Also, it has the advantage of greater radiant brightness and the fact that this brightness is highly directional even after travelling long distances, the size of the emitting system is greatly reduced.

#### 3.1.2 Laser Bomb Designators

The military has enjoyed a considerable amount of success in developing laser devices for use on the battlefield. These devices, which greatly improve the accuracy of normal conventional weapons, include range finders and bomb designators. A range finder calculates the distance, or range, to a desired target by measuring how long a small burst of laser light takes to travel to the target.

A laser bomb designator works by shining a low-powered laser beam at the desired target. After the target has been designated, a bomb is released, either from an airplane or from a ground-based missile; this is known as a "smart" bomb because it carries a sensor that can detect the laser beam and use it to home in on and destroy the target. The military first used such devices on the battlefield in 1972 during the Vietnam War, and much improved versions proved highly successful in the Persian Gulf War (in 1991) and especially in the police action against terrorists in Afghanistan (in 2001).[16]

#### 3.1.3 Simulating battle conditions

Lasers have also proved to be successful in simulating mock battles that are staged to give soldiers practice for the real thing. Before lasers, these simulations had not been as realistic as military officials would have liked. Obviously, the soldiers on opposing teams could not really fire at each other, so referees had to decide who had or had not been "hit."

In laser battle simulations, soldiers fire special guns that shoot bursts of light. Sensors are attached to each soldier who fights in the battle; such sensors are also attached to tanks, trucks, or any other vehicles used in the mock fighting.

#### 3.1.4 Underwater Communication

Another dramatic use for the military laser is in the area of submarine (underwater) communications. Submarines often patrol in enemy waters, and in the past the only way an admiral could get a message to a sub was by using ordinary radio. But this has two serious disadvantages: First, radio waves do not travel well underwater and require large antennas to

broadcast those long distances. Second, there is always the risk that the enemy will pick up the signal, which immediately reveals the sub's location and exposes it to danger

To send a message to a submarine the navy uses a laser that gives off a monochromatic beam of blue-green light. This particular shade of blue-green light travels easily through ocean water. The beam carrying the message is transmitted to a satellite orbiting high above the ocean

If there are any enemy on lookouts nearby, it is unlikely they will know about the signal beam, which the satellite flashes for only a few millionths of a second. This is not enough time for the lookouts to see the beam with their naked eyes

### **3.2 Communications**

A very useful and interesting application of laser is in the field of communications, which takes advantage of its wide bandwidth and narrow beam width over long distances. The laser beams can be created in a range of wavelengths from the ultraviolet to the infrared regions of the electromagnetic spectrum. The color of the emitted light is relatively not important.

The advent of semiconductor lasers has made possible the use of lasers for signal transmission. They are excited directly by electric current to yield a laser beam in the invisible infrared region. A particular aspect of laser transmission, which makes it preferable to the ordinary radio waves for military purposes is the strict secrecy provided by the narrow beam width.[17]

The optical laser has a great potential for use in long distance communication. Since the capacity of a communication channel is proportional to the frequency band width, at optical frequencies, the information carrying capacity is many times more than that is possible at lower frequencies. This and the fact that the laser is a generator of highly coherent beams which are powerful and sharply directed, make it ideally suited for communications. [17]

### **3.3 Wireless power driven propulsion**

Laser or microwave-driven acceleration by photon reflection has been proposed for propelling spacecraft for science missions to the outer solar system and even to nearby stars. In principle, such wireless beam driven probes have the advantage that energy is used for the acceleration of only the payload (and the receiving/ reflecting structure usually called a "sail") but not the propelling beam generator [2].

### **3.4 LCRD**

NASA successfully tested the LCRD (Laser Communication Relay Demonstration) for transmission of data 10 times faster than the conventional R.F. method and will launch a fully operational module in 2017 making a giant leap towards high transmission rates. [18]

### **3.5 TALON**

Harris, an American communications, defense contractor and IT services has developed TALON (Tactical Line-of-sight Operational Network) with the help of which navy ships can communicate at high speeds with each other, it also provides high speed video conferencing and has been tested up to 53 miles in the sea. [19]

### **3.6 Fully independent rover vehicle**

In 2002 and 2003, a demonstration of ground to ground wireless power transmission via laser to a small, otherwise fully independent rover vehicle equipped with photovoltaic cells was performed by Steinsiek and Schâfer ,as a first step towards the use of this technology for powering airships and further in the future lunar surface rovers. [6] The experiment was based on a green, frequency-doubled Nd:YAG laser at only a few Watts. It included the initiation and supply of the rover including a micro-camera as payload as well as the pointing and tracking of the moving rover over a distance up to 280 m by applying active control loops.[2](Fig 5)





**Figure 5:** EADS developed, fully laser powered autonomous rover. (Source: EADS) [10][11]

Recently, similar experiments, however focusing less on the beam control and beam steering aspects but rather on the total transmitted power levels have been carried out in the frame of a context related to space elevators, organized and co-funded by NASA. Ground-based lasers have been used to power small PV-covered “climbers” attached to a tether with the objective to achieve maximum climbing speeds [2][7][8].

### 3.7 Laser power transmission

The use of laser based wireless power transmission was revisited in the early 1990s by Landis. [9][10] Since several years, the Japanese space agency JAXA (Japan Aerospace eXploration Agency) is pursuing a solid and targeted R&D programme towards the development of space based solar power stations, including as the two main technical options the microwave and laser based concepts. New designs and laser system options have been proposed.[2]

The JAXA proposed laser based system is based on direct solar pumped lasers using a Nd:YAG crystal. A reference system has been designed, delivering 1 GW. The entire system would be built in a highly modular way, with individual modules of 100 m x 200 m primary mirrors and an equally large radiator system as base unit delivering 10 MW each and stacked to a total length of 10 km in orbit.(Fig 6, Fig 7, Fig 8 ) [2][11][12]

In 2004, JAXA and the Osaka based Institute for Laser Technology have successfully performed an experiment with direct solar pumped laser beam (using simulated solar light and a fiber laser medium made from a neodymium-chrome doped YAG (Nd-Cr:YAG) crystal and disc type bulk crystal) with conversion efficiencies from the input power to the output laser power with 37%. [13][2]

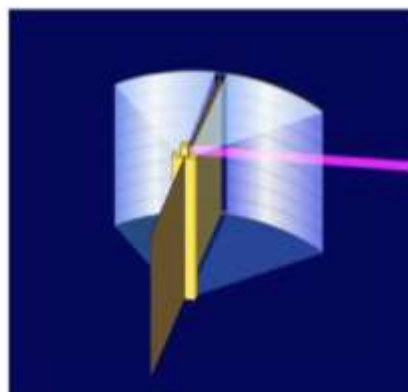

**Figure 6.** JAXA L-SPS 100x200 m reference unit delivering 10 MW via direct solar pumped lasers. (Source: JAXA) [11][12]

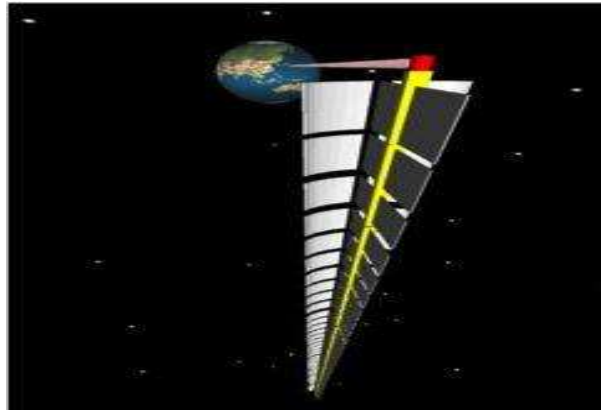

**Figure 7.** JAXA L-SPS fully deployed reference system delivering 1 GW via direct solar pumped lasers. (source: JAXA), deployed in the orbit of Earth, made of 10 MW unit each, Spread in 10 Kms)[11][12]

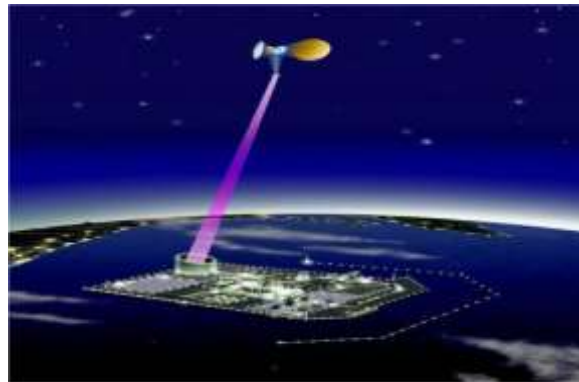

**Figure 8.** JAXA L-SPS system transmitting power with the help of laser to the station present on the surface of the Earth. (Source: JAXA)[11][12]

#### IV. Conclusion

Laser mortal is applied to send information from one pc to a different at speeds that the wireless networks won't be able to offer. Another network that this method can surpass is that the fiber optical network, as this method can minimize the setup physically and additionally financially. The implementation of ANY of those systems in an inter-satellite link would force a considerable development effort. The strengths and weaknesses of the varied varieties of optical devices presently obtainable for laser communications ought to be fastidiously thought of. supported existing laser's characteristics, the GalAs system, particularly the full-bandwidth, direct detection system is that the most engaging for lay to rest satellite links as a result of its inherent simplicity and also the expected high level of technological development.

The system and part technology necessary for flourishing lay to rest satellite link exists nowadays. The growing needs for the economical AND secure communications has LED to an magnified interest within the operational readying of optical device cross-links for industrial and military satellite systems in each low earth and geo-synchronous orbits. With the dramatic increase within the information handling needs for satellite communication services, optical device lay to rest satellite links provide a horny various to RF with nearly unlimited potential. until currently information transfer passed off either through wireless networks (Wi-Fi) or through wired networks (cables). The optical device technique aims to vary the media of communication and at identical time confine thought value constraints and additionally offer higher information rates. additionally scientific discipline techniques is applied

for side security to the info. the fundamental thought remains identical as that of the optical device mortal. Input is taken from the computer and born-again to code juicer that it'll be simple to convert the 'dot' and 'dash' to voltages and so wont to power up the optical device. This optical device are going to be directed to the target computer having a receiver of ether photodiode or solar battery to capture the sunshine and sense the voltages and expire to the applying as code and so

more decoded to the data. All Computers of a science lab is connected to every alternative through an immediate on-line link with its facilitate while not victimization any cables and additionally while not compromising on the speeds.

## References

- [1] [http://www.ijarcse.com/docs/papers/April2012/Volume\\_2\\_issue\\_4/V2I40056.pdf](http://www.ijarcse.com/docs/papers/April2012/Volume_2_issue_4/V2I40056.pdf). International Journal of Advanced Research in Computer Science and Software Engineering Research Paper: Research Issues in Wireless Networks.
- [2] [Concepts for wireless energy transmission via laser by Leopold Summerer, Oisin Purcell. (<http://www.spaceward.org/elevator2010-pb>)
- [3] H. Singh and S. Singh, –Energy Consumption of TCP Reno, Newreno, and SACK in Multi-Hop Wireless Networks II ACM SIGMETRICS Perf. Evaluation Rev., vol. 30, no. 1, June 2002, pp. 206-216.
- [4] Chip Craig J. Mathias Principal, Farpoint Group COMNET 2003 –Wireless Security: Critical Issues and Solutions|| 29 January 2003
- [5] IEEE 802.11-1999, IEEE Standard for Local and Metropolitan Area Networks Specific Requirements – Part 11: Wireless LAN Medium Access Control (MAC) and Physical Layer (PHY) Specifications, June 12, 1999.
- [6] Frank Steinsiek, W. P. Foth, K. H. Weber, Christian Schäfer, and H. J. Foth. Wireless power transmission experiment as an early contribution to planetary exploration missions. In IAC 2003. IAF, Oct. 2003.
- [7] The space elevator - from concept to reality, December 2008. <http://www.spaceelevator.com> (accessed December2008).
- [8] Spaceward Foundation. Power beaming (climber)competition <http://www.spaceward.org/elevator2010-pb> (accessed December 08).
- [9] G. A. Landis. Applications for space power by laser transmission. In Proceedings SPIE, volume 2121, pages 252-255, 1994.
- [10] Masahiro Mori, H. Kagawa, and Y. Saito. Current status of a study on hydrogen
- [11] Production with space solar power systems (SSPS). In L. Summerer, editor, SPS'04 Conference - Solar Power from Space, Granada, Spain, June 30 - July 2 2004. ESA.
- [12] Hiroaki Suzuki, Tatsuhito Fujita, and Masahiro Mori. Technology demonstration and elemental technology development of space solar power systems. In Proceedings of the IAC, number IAC-06-C3.2.4. IAF, 2006.
- [13] Masahiro Mori. Medium efficiently converts solar rays into laser beams. The Japan Times, September, 9 2004.
- [14] <http://www.wirelesscommunication.nl/reference/chaptr07/history.htm>
- [15] [https://www.nasa.gov/sites/default/files/llcdfactsheet.final\\_web\\_.pdf](https://www.nasa.gov/sites/default/files/llcdfactsheet.final_web_.pdf)
- [16] <http://www.scienceclarified.com/scitech/Lasers/Military-Applications-of-Lasers.html>
- [17] <http://electrofriends.com/projects/basic-electronics/laser-communication-system/2/>
- [18] [https://www.nasa.gov/mission\\_pages/tdm/lcrd/index.html](https://www.nasa.gov/mission_pages/tdm/lcrd/index.html)
- [19] <https://www.harris.com/press-releases/2014/03/video-exelis-laser-communications-system-connects-deployed-forces-in-any>