

Cascaded Multilevel Inverter with MPPT for Grid connected PV System

Dinesh Kumar¹, Dinesh Menaria², Farhat Khanam³, Gaurav Jain⁴, Mrs. Monika Vardia⁵

^{1,2,3,4,5}EE DEPARTMENT GITS,UDAIPUR

Abstract-This paper presents a cascaded multilevel inverter with MPPT for grid connected application. Interconnection of solar and grid is a most demanding topic now a days. The main purpose of this paper is to design a multilevel inverter based on artificial intelligence technology and develop the Simulink model of cascaded multilevel inverter for grid connected pv system. Used individual MPPT technique for each solar panel to extract maximum power from solar panel and it is improve the overall efficiency of system. The simulation model has been developed by using MATLAB/Simulink.

Keywords- photovoltaic (PV), maximum power pointtracking(MPPT), cascaded multilevel inverter.

I. INTRODUCTION

Renewable energy sources have become a major necessity of today's era because conventional energy sources are highly exhaustible and will deplete very soon in the nearest future. Photovoltaic is one of the important renewable energy sources compared to other renewal energy sources. Solar energy is considered a very promising source for electric power generation. Two technologies which are widely used today to provide power are either standalone loads or for connection to the power system grid. A standalone solar photovoltaic system cannot provide a continuous supply of energy due to seasonal and periodic variations. Therefore, in order to meet the load demand, grid connected energy systems are now being implemented. Distributed power generation systems are widely recognized as an unpreventable trend in today's power utilities. Among them, the use of photovoltaic (PV) solar energy for grid connected application is fast growing market. Since the PV technology has some insuperable features, such are noiseless, fuel- and pollution- free generation, lack of wearing parts and high reliability; it has potential to become a main renewable energy source of the future. For maximum utilization distributed power systems are the most suitable in photovoltaic power systems. Cascaded H-Bridge type multilevel inverters are the appropriate one for the distributed photovoltaic power system. Fuzzy logic based intelligent controller is used in continuous

monitoring of the grid connected photovoltaic power system and controlling the cascaded H-bridge inverter.

II. SYSTEM DESCRIPTION

A. About block diagram

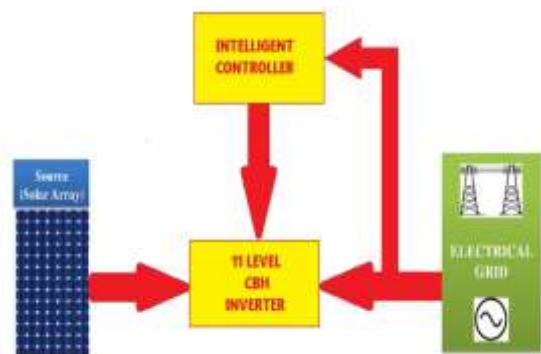

Figure 1 Block Diagram of grid connected PV power system

The cascaded inverter topologies are chosen for grid-connected PV systems to reduce the cost and improve the efficiency.

In cascaded inverter topologies several converters are connected in series to reach the high voltage/power level. This will reduce voltage stresses on the semiconductor switches in each converter. Therefore, low voltage rating MOSFETs, which cost less, can be even applied to large-scale PV systems to reduce the cost of PV inverters. Also, the cascaded PV inverter can reach a high power level without having to sacrifice the utilization of PV modules, leading to a high overall efficiency of PV systems. In addition, compared to other converter topologies, the cascaded topology itself has higher efficiency due to the low switching frequency. By applying the cascaded topology, the target of high efficiency will be achieved as well. Thus, the cascaded H-bridge multilevel inverter is applied to single-phase grid-connected PV systems. The control scheme with individual MPPT control will be developed to improve the overall efficiency of the system. But the solar powered multi-level inverter introduces a lot of harmonics. Therefore fuzzy logic based intelligent controller has been implemented for voltage regulation at Point of Common Coupling of Grid connected PV Power System.

B. Modelling of a solar cell

The simplest equivalent circuit of a solar cell is a current source in parallel with a diode. The output of the current source is directly proportional to the light falling on the cell (photocurrent I_{ph}). During darkness, the solar cell is not an active device; it works as a diode, i.e. a p-n junction. It produces neither a current nor a voltage. However, if it is connected to an external supply (large voltage) it generates a current I_D , called diode (D) current or dark current. The diode determines the I-V characteristics of the cell.

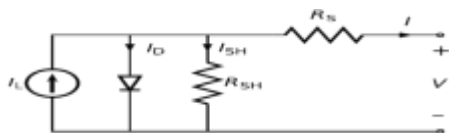

Figure 2 The equivalent PV cell circuit

C. Cascaded H- bridge Inverter

The multilevel inverter using with separate DC source may be obtain from batteries, fuel cell and solar cell. Nowadays this topology becomes very popular in high power supply and adjustable speed drive application. When two or more H- bridge connecting in series their output voltage can be combine to from different output levels, increasesing total output voltage and its rated power also increases. In general term when n number of H- bridge connected in series $2n+1$ different voltage level is obtained.

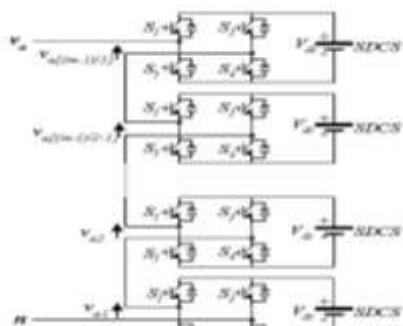

Figure 3 single phase structure of a multilevel cascaded H- bridge inverter.

III. PV CELL CHARACTERISTICS

Nonlinear Characteristic Of Pv's

Photovoltaics have nonlinear characteristics, where the performance and output power are directly affected with the change of the operating conditions like temperature and solar irradiance. Figures 4, 5, 6 and 7 shows the effect of change in temperature and solar irradiance on PV's output current, voltage and power.

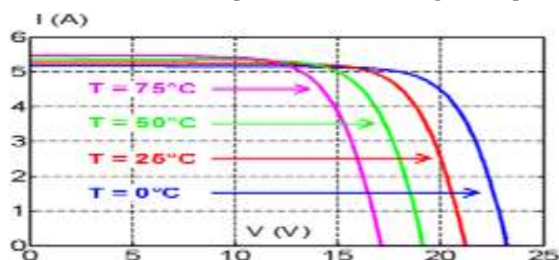

Figure 4 Effect of temperature changes on I-V curves

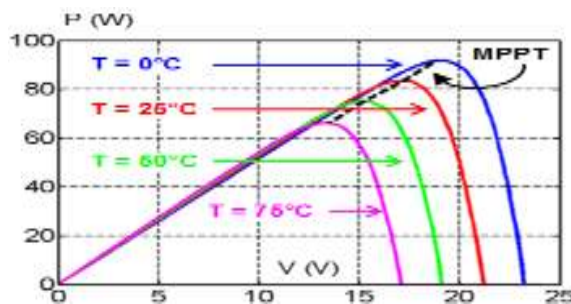

Figure 5 Effect of temperature changes on P-V curves.

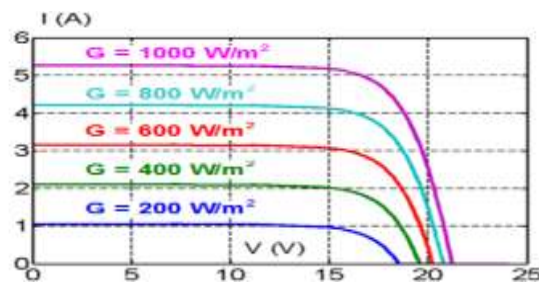

Figure 6 Effect of solar irradiance changes on I-V curves

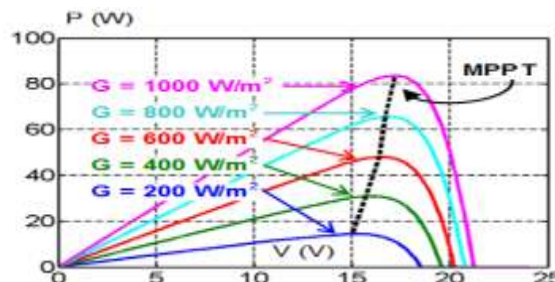

Figure 7 Effect of solar irradiance changes on P-V curves

IV. PROPOSED MODEL

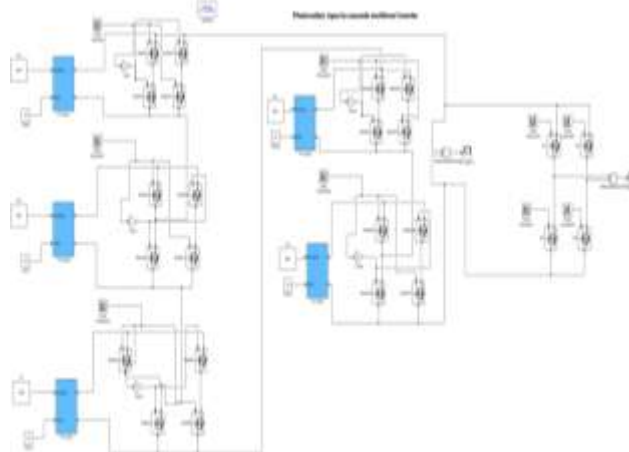

Figure 8 Photovoltaic Input to cascaded Multilevel Inverter

V. SIMULATION RESULTS

The simulation is performed in Matlab Simulink.

A. Effect of different irradiance

The characteristics of the SunPower-SPR305 and Kyocera 205GX-LP array are shown in Fig. 9 to 12 below.

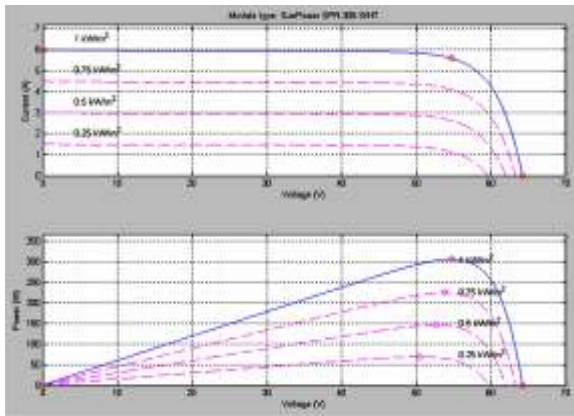

Fig.9: I-V and P-V characteristics of one module at 25°C and at different irradiance

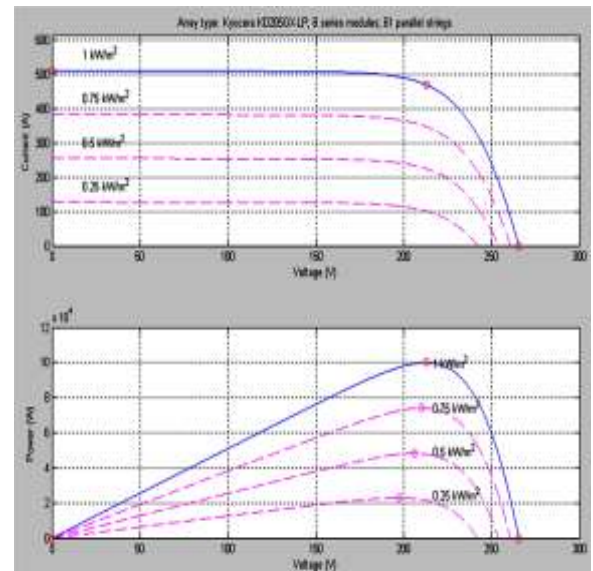

Figure12 I-V and P-V characteristics of string at 25°C and at different irradiance

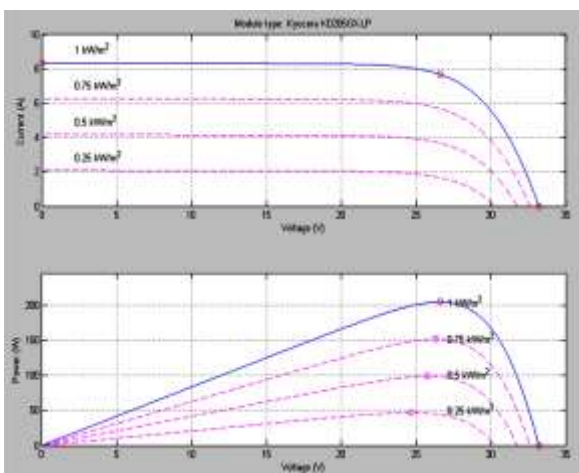

Fig.10: I-V and P-V characteristics of string at 25°C and at different irradiance

B. Effect of Change of Temperature

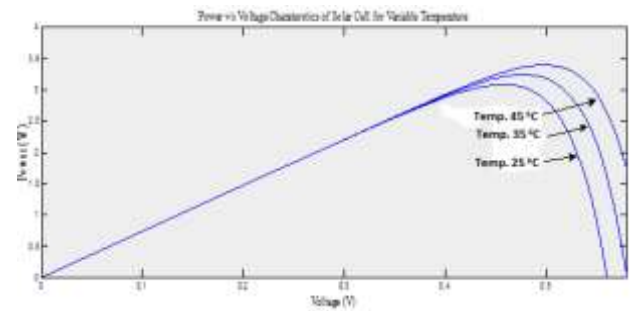

Fig.13: Power v/s Voltage characteristic of PV system at standard irradiance and at different temperature

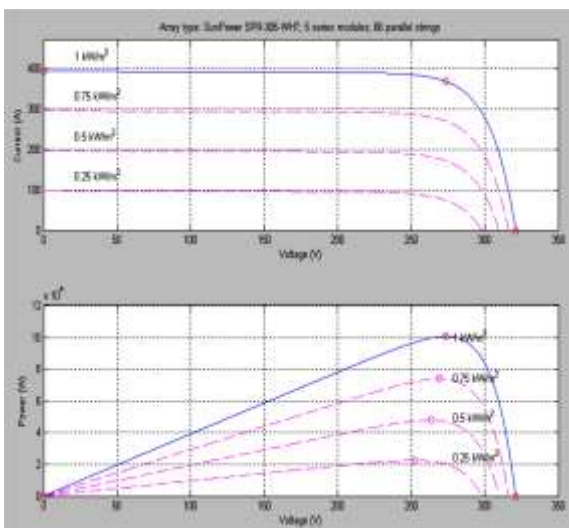

Fig.11: I-V and P-V characteristics of one module at 25°C and at different irradiance

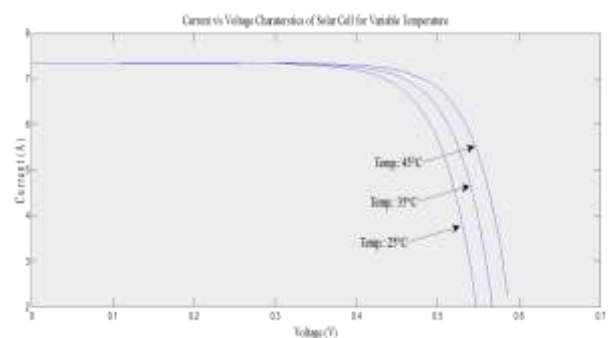

Fig.14: Current v/s Voltage characteristic of PV system at standard irradiance and at different temperature

C. Effect of change of Irradiance

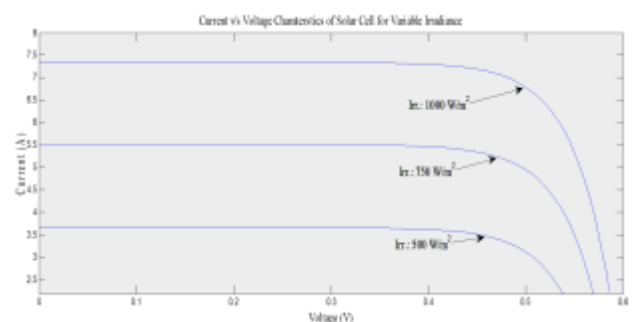

Fig.15: current v/s voltage characteristic of cell at standard temperature and at different irradiance

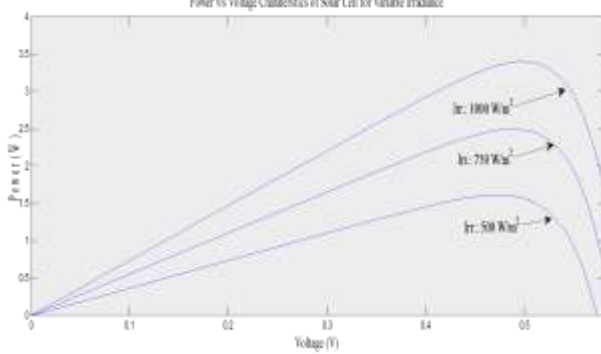

Fig.16: Power v/s voltage characteristic of cell at standard temperature and at different irradiance

D. Simulation of PV system without MPPT control

Simulations were performed on the proposed PV system when MPPT is disabled to illustrate the effect of duty cycle of boost converter on performance parameters of the proposed system. The simulation presents an analysis of the photovoltaic array 200.8 kW with the boost converter to track the maximum power point.

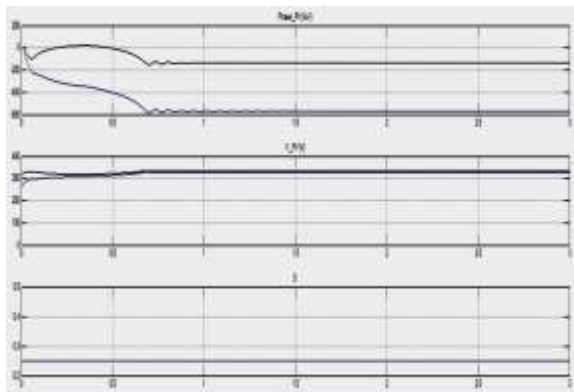

Figure.17: Plot of output voltage, power and duty cycle. (D=0.25)

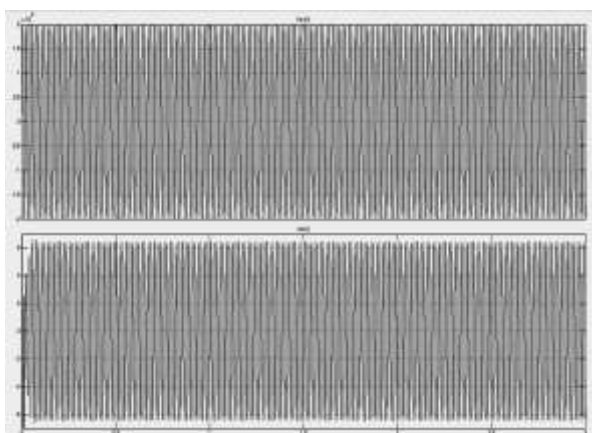

Figure.18: Output load voltage and load current of PV system

E. Response of the Proposed PV Model with "Perturb and Observe" MPPT Technique

(a) Under Constant Irradiance

In this case, Irradiance is kept constant at 1000 W/m² and P & O MPPT technique is applied to control the

duty cycle of the dc- dc boost converter so as to track the maximum power.



Time(t) sec

Figure 19: Waveforms of the Vref- Vmean, Modulation Index and the Irradiance



Time (t) sec

Figure 20: Waveforms of the Irradiance, Mean Power, Voltage, Duty Cycle

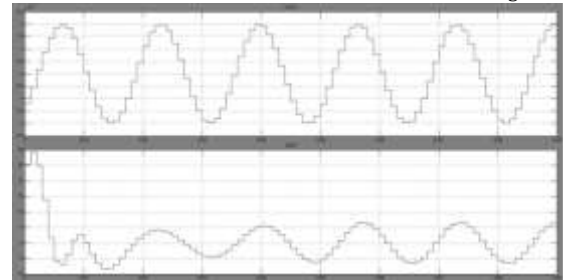

Figure 21 : Waveforms of the Grid Voltage and Grid current



Figure 22 :Waveforms of the Grid Power



(b) Under Step Irradiance

In this case Irradiance is initially kept at 1000 W/m² and changed to 200 W/m² at t=0.5 sec. and again step increased to 1000 W/m² at t=0.7 sec.

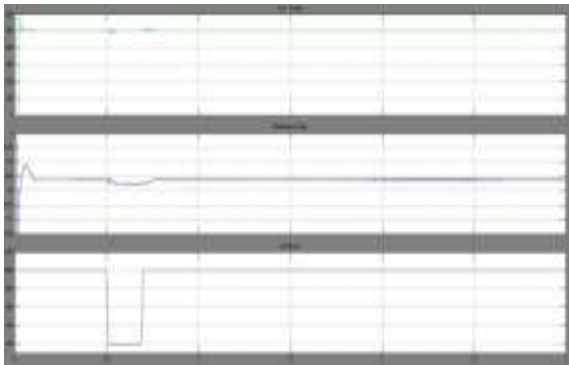

Figure 24: Waveforms of the Vref-Vmean, Modulation Index and the Irradiance

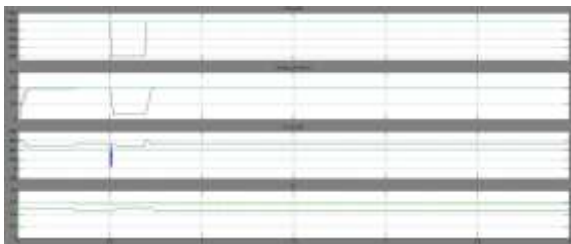

Figure 25 : Waveforms of the Irradiance Mean Power, Voltage, Duty Cycle

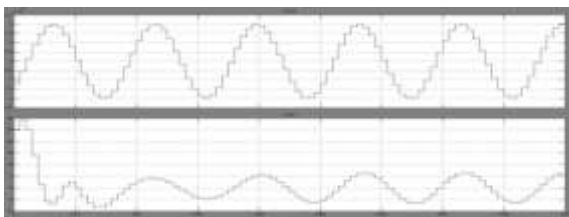

Figure 26 :Waveforms of the Grid Voltage and Grid current



Figure 27 : Waveforms of the Grid Power

VI. CONCLUSIONS

In this thesis, the study of the photovoltaic system integrated with grid has been developed with maximum power point controller. A Photovoltaic array is developed in MATLAB Simulink model. The photovoltaic system with DC-DC boost converter, maximum power point controller and multilevel inverter has been designed and simulated with Simulink MATLAB. System performance is examined under different conditions and following points can be concluded:

1. The multilevel inverter employed eliminates the need of transformer because it can directly be connected to high voltage sources, this means a reduction of implementation and costs.

2. The multilevel inverter employed provides suitable voltage with the right frequency and phase angle for interconnection to the grid.
3. According to IEEE standard 929 power factor (>0.85) and operating range of output voltage ($106 \leq V \leq 132$) of PV is validated.

REFERENCES

1. J.M Carrasco et al., power electronics system for the grid integration of Renewable energy sources; A Survey in IEEE Transactions on industrial electronics, vol, 53, No,4pp1002-1006 June 2006
2. T.esram and P.L. Chapman, comparison of photovoltaics Array Maximum power point tracking's techniques, in iee transactions energy conversion, vol.22,no. 2,pp. 439- 449,june 2007
3. Hung-Liang Cheng, Yao-Ching Hsieh and Chi-Sean Lin, "A Novel Single-Stage High-Power-Factor AC/DC Converter Featuring High Circuit Efficiency," *IEEE Transactions ON Industrial Electronics*, VOL. 58, NO. 2, FEBRUARY 2011. PP (524-532).
4. Yu-Huei Lee, Shao-Chang Huang, Shih-Wei Wang, Wei-Chan Wu, Ping-Ching Huang, Hsin-Hsin Ho, Yuan-Tai Lai and Ke-HorngChen,"Power-Tracking Embedded Buck-Boost Converter With Fast Dynamic Voltage Scaling for the SoC System," *IEEE Transactions on Power Electronics*, VOL. 27, NO.3, MARCH 2012. PP (1271-1282).
5. Hossein Nasiri Avanaki; Reza Barzegarkhoo; Elyas Zamiri, A Switched-Capacitor Multilevel Inverter for grid-connected PV systems with MPPT ability and reduced components, 2018 9th Annual Power Electronics, Drives Systems and Technologies Conference (PEDSTC), Pages: 224 – 230.