

# IMPLEMENTATION OF CONTINUES BODY MONITORING SYSTEM WITH WIRELESS BODY SENSOR NETWORKS (WBSN) USING IOT APPLICATION

E.Ramakrishna Reddy<sup>1</sup>, Dr.B.Nancharaiah<sup>2</sup>, K.Babu Rao<sup>3</sup> K.Naga Ravi Kumar<sup>4</sup>

<sup>1</sup>Asst. Proff., Electronics & Communication Engg., Usha Rama College of Engg. , Andhra Pradesh,

<sup>2</sup>Proff, & HoD, Electronics & Communication Engg., Usha Rama College of Engg. , Andhra Pradesh,

<sup>3</sup>Assoc Proff., Electronics & Communication Engg., Usha Rama College of Engg. , Andhra Pradesh,

<sup>4</sup>M.Tech, Student Electronics & Communication Engg., Usha Rama College of Engg. , Andhra Pradesh

\*\*\*

**Abstract** - ECGs are important biomedical signals, which are reflective of an electric activity of the heart. They form a subject of intensive research for over 100 years. ECG signals are one of the best-understood signals being at the same time an important source of diagnostic information. Because of this, in the recent years there has been a steady and intensive research with intent of developing efficient and effective methods of processing and analysis of ECG signals with emphasis on the discovery of essential and novel diagnostic information. This chapter offers a comprehensive overview of main problems concerning analysis and signal processing in ECG systems.. The chapter is arranged into three parts. In the first one, we focus on the essentials of ECG signals, its characteristic features, and the very nature of the associated diagnostic information. In the second part, we elaborate on a sequence of phases of ECG signal processing, and analysis as they appear in ECG systems. Finally, in the third part, we offer a description of essential ECG tests.

**KEY WORDS**

Digital processor, Parallel prefix, Wireless sensor network (WSN)

**1. INTRODUCTION**

At present, heart disease is one of serious diseases that may threaten human life. The Electrocardiogram (ECG) is important role in the prevention, diagnosis the abnormality of patients and rescue of heart disease. In progress has been made in the development of a remote monitoring system for ECG signals, the deployment of packet data services over telecommunication network with new applications. The tele-transmitting and receiving of ECG signal is the key problem to realize the tele-diagnosis and monitoring of ECG signals. Telemedicine is the use of medical information exchanged from one site to another via electronic communications to improve patients' health status.

Telemedicine is a newest technology which combining telecommunication and information technology for medical purposes. It gives a new way to deliver health care services when the distance between the doctor and patient is significantly away. Rural area will get the benefit from this application. Patient monitoring is one of the telemedicine, which always needs improvement to make it better.

**1.1 EXISTING SYSTEM**

As the existing ECG systems are cost high and complex to handle .As the number of heart disease patients are increasing hospitals needs more amount of budget to install ECG systems. In existing system patient is monitored using bedside monitoring station with wired sensors, which makes the patients to be periodically monitored by doctors/nurses.

It is impossible to collect the data for wider range and coverage of wireless network is not available. We cannot send that ECG data to any other doctor in treating patients

**1.2 PROPOSED SYSTEM**

Now our proposed system which is available to all the people, cost friendly and easily carry to the different places to get the ECG data from the patients because complexity of wiring is less and maintain to easy. We can treat the patients who are significantly away from the doctors and transmit the ECG data to anyone in this world. As the cost is friendly it can install in large number and also makes easy to monitor the patient continuously.

**2. BLOCK DIAGRAM**

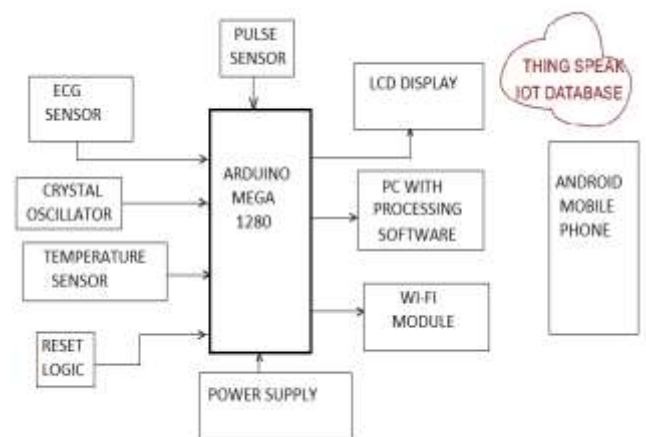

**2.1 BLOCK DIAGRAM DESCRIPTION**

- Block diagram consists of the Arduino mega 1280, temperature sensor, Wi-Fi module, power supply, Pulse sensor and ECG sensor.

- Arduino mega 1280 is a micro controller board based on the ATmega1280
- ECG allows you to assess the electrical and muscular functions of the heart.
- The wifi module ESP8266 is a self contained soc. It is capable of either hosting an application all wifi networking functions from another application processor.
- Power supply is electrical device that supplies electrical power to an electrical load. The primary function of the power supply is to convert the electrical current and frequency to power the load.

Thing speak is a platform providing various services exclusively targeted for building IoT applications. It offers the capabilities of the real time data collection, visualizing the collected data in the form of charts

### 2.2 CIRCUIT DIAGRAM

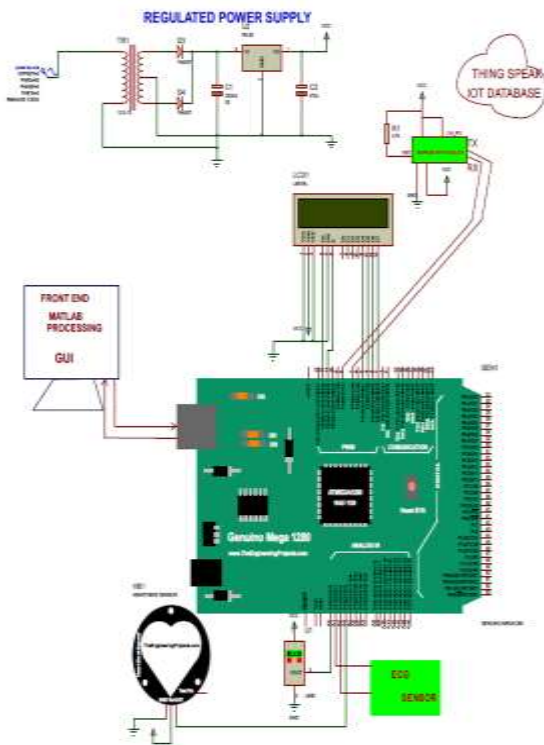

### 2.3 WORKING OF CIRCUIT

When the ECG, temperature, pulse sensors starts the capturing the data of temperature, heartbeat, pulse rate from the patient is directly sends to Arduino mega micro controller. As the Arduino has a default Analog-to-digital convertor, the analog data captured by the sensors are converted into digital data and this converted data is sends to cloud (updated for every 5 seconds) through Wi-Fi module.

This cloud data is accessed by any person or any doctors anywhere in the world with the help of thing speak android application or by things speak website. As well as

the ECG waveform output can also visible through the monitor/laptop, Lcd display as the Arduino board is connected to it. With the help of obtained data the distant doctor can able to treat the patient away from the hospital. By this way Tele-medicine application is implemented.

## 3 ARDUINO MEGA 1280

### 3.1 INTRODUCTION

This is the original Arduino Mega fitted with the 1280 chipset. The only difference between this chip and the newer 2560 chip fitted to the Arduino Mega 1280 is the amount of Flash Program memory onboard. The 1280 has 128Kb Flash, while the 2560 has 256Kb Flash. So if you need an Arduino Mega but don't need the large amount of programming space that the 1280 has, then perhaps this one is for you.

As the Mega 1280 board is no longer manufactured by Arduino, this is a clone board made in china. But don't let that put you off, it is still a quality board.

The **Arduino Mega 1280** is a microcontroller board based on the ATmega1280. It has 54 digital input/output pins (of which 14 can be used as PWM outputs), 16 analog inputs, 4 UARTs (hardware serial ports), a 16 MHz crystal oscillator, a USB connection, a power jack, an ICSP header, and a reset button.

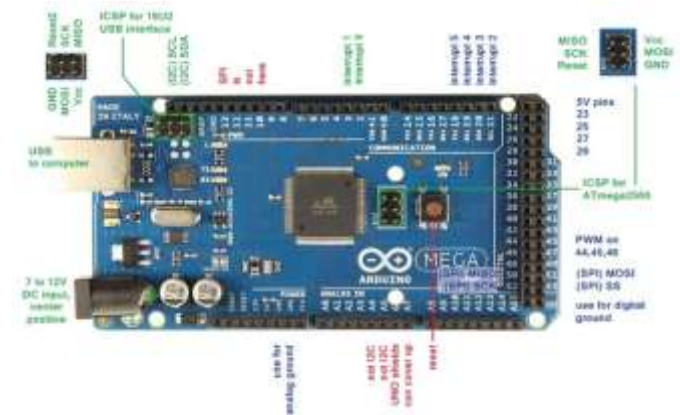

**ARDUINO MEGA 1280**

### 3.2 Arduino Mega 1280 Features

- Microcontroller ATmega1280
- Operating Voltage 5V
- Input Voltage (recommended) 7-12V
- Input Voltage (limits) 6-20V
- Digital I/O Pins 54 (of which 14 provide PWM output)
- Analog Input Pins 16

- DC Current per I/O Pin 40 mA
- DC Current for 3.3V Pin 50 mA
- Flash Memory 128 KB of which 8 KB used by boot loader

### 3.3 RASPBERRY PI KIT:



The **Raspberry Pi** is a series of credit card-sized single-board computers developed in England, United Kingdom by the Raspberry Pi Foundation with the intent to promote the teaching of basic computer science in schools and developing countries. The original Raspberry Pi and Raspberry Pi 2 are manufactured in several board configurations through licensed manufacturing agreements with Newark element14 (Premier Farnell), RS Components and Egoman. The hardware is the same across all manufacturers.

### 4. ESP 8266 (WI-FI MODULE)

ESP8266 offers a complete and self-contained Wi-Fi networking solution, allowing it to either host the application or to offload all Wi-Fi networking functions from another application processor.

When ESP8266 hosts the application, and when it is the only application processor in the device, it is able to boot up directly from an external flash. It has integrated cache to improve the performance of the system in such applications, and to minimize the memory requirements.

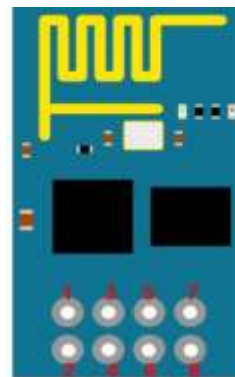

#### ESP8266 Pins

1. GND - Circuit Ground
2. TX - UART0 Transmit
3. GPIO2 - General Purpose I/O
4. CH\_EN - Chip Enable, Active High
5. GPIO0 - General Purpose I/O
6. RESET - Reset, Active Low
7. RX - UART0 Receive
8. VCC - Circuit Power = +3.3V DC

ESP8266 TOP VIEW

### 5. ECG SENSOR 8232

The AD8232 is an integrated signal conditioning block for ECG and other bio-potential measurement applications. It is designed to extract, amplify, and filter small bio-potential signals in the presence of noisy conditions, such as those created by motion or remote electrode placement. This design allows for an ultralow power analog-to-digital converter (ADC) or an embedded microcontroller to acquire the output signal easily.

The AD8232 can implement a two-pole high-pass filter for eliminating motion artifacts and the electrode half-cell potential. This filter is tightly coupled with the instrumentation architecture of the amplifier to allow both large gain and high-pass filtering in a single stage, thereby saving space and cost

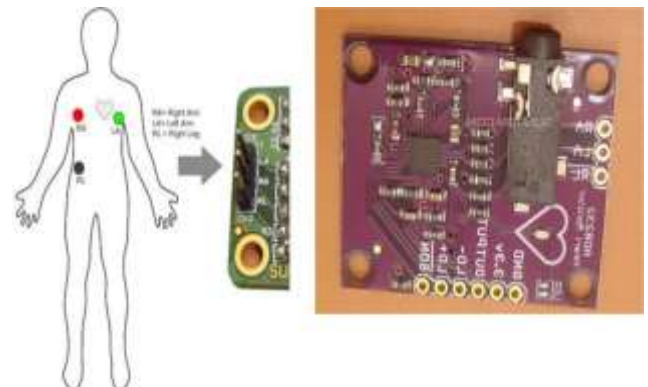

#### FEATURES

- Fully integrated single-lead ECG front end
- Low supply current: 170  $\mu$ A (typical)
- Common-mode rejection ratio: 80 dB (dc to 60 Hz)
- Two or three electrode configurations
- High signal gain ( $G = 100$ ) with dc blocking capabilities
- 2-pole adjustable high-pass filter
- Accepts up to  $\pm 300$  mV of half cell potential
- Fast restore feature improves filter settling
- Uncommitted op amp



- 3-pole adjustable low-pass filter with adjustable gain
- Leads off detection: ac or dc options
- Integrated right leg drive (RLD) amplifier
- Single-supply operation: 2.0 V to 3.5 V

**6. PULSE SENSOR**

Pulse Sensor is a well-designed plug-and-play heart-rate sensor for Arduino. It can be used by students, artists, athletes, makers, and game & mobile developers who want to easily incorporate live heart rate data into their projects. The sensor clips onto a fingertip or earlobe and plugs right into Arduino with some jumper cables. It also includes an open-source monitoring app that graphs your pulse in real time.



**FIG 6.1: PROJECT HARD WARE ARCHITECTURE**

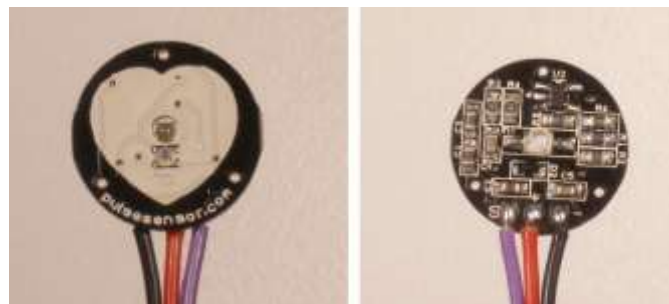

**PULSE SENSOR**

**7. SOFTWARE IMPLEMENTATION**

**ARDUINO IDE SOFTWARE**

The ARDUINO Integrated Development Environment - or ARDUINO Software (IDE) - contains a text editor for writing code, a message area, a text console, a toolbar with buttons for common functions and a series of menus. It connects to the ARDUINO and GENUINO hardware to upload programs and communicate with them.

**8. RASPBERRY PI 3 UBIDOTS SOFTEARE**

The basics components of any Internet of Things application powered by Ubidots are: Devices, Variables, Synthetic Variables Engine, Dashboards, and Events. Within this article we will address each of these concepts as they relate to Ubidots IoT Development and Deployment Platform and how you can better organize your Ubidots Apps to best connect with the users.

**9. RESULTS AND ANALYSIS RESULTS**

The following are the results which obtained from this work,

- Transmission of ECG data wirelessly to any doctor.
- The ECG data can be accessed anytime and from anywhere the real-time data transmission and access takes place.

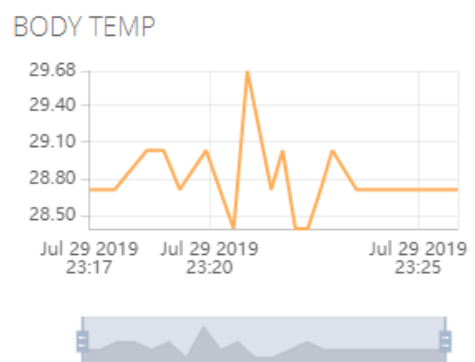

**FIG: 6.2 TEMPERATURES READING OF PATIENT**

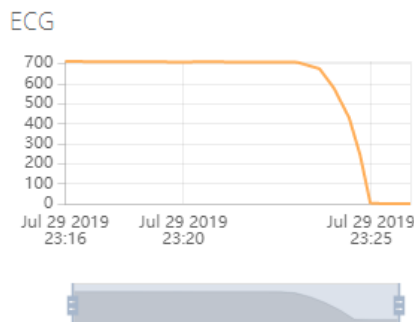

**FIG: 6.7 MONITORING OF ECG AND TEMPERATURE OF PATIENT**



### PATIENT PULSE DATA APPLICATIONS

The following are the applications achieved by IoT based patient health care monitoring system.

- It is one of the Tele-Medicine.
- Able to install in Rural Areas.
- Can also use in ICU , CCU.
- Using in Ambulance.
- Out Patient Care.
- Helpful in patient Recovery Rooms.
- Continues body monitoring with wearable devices

### 10. ADVANTAGES

The following are the advantages achieved by IoT based patient health care monitoring system.

IoT Monitoring proves really helpful when we need to monitor & record and keep track of changes in the health parameters of the patient over the period of time. So with the IoT health monitoring, we can have the database of these changes in the health parameters. Doctors can take the reference of these changes or the history of the patient while suggesting the treatment or the medicines to the patient.

### 11. CONCLUSION AND FUTURE SCOPE

We can add a GPS module in IoT patient monitoring using Arduino MEGA and WiFi module project. This GPS module will find out the position or the location of the patient using the longitude and latitude received. Then it will send this location to the cloud that is the IOT using the Wi-Fi module. Then doctors can find out the position of the patient in case they have to take some preventive action

We have implemented IoT based patient health care monitoring system in order to get ECG from the patient and transmits the ECG data to anywhere in this world instantaneously and ECG data can able to access by anybody with the help of smart phone or a personal computer. By implementing this proposed system the cost reduction, resource optimization, effective usage of smart ECG systems can be done **9.1**

### 12. REFERENCE ONLINE LINKS

- [1] Mehmet Ustundag, Muammer Gokbulut, Abdulkadir Sengur and Fikret Ata, "Denoising of Weak ECG Signals by using Wavelet Analysis and Fuzzy Thresholding", Springer Network Modeling Analysis in Health Informatics and Bioinformatics, Volume 1, Issue 4, pp 135-140, 2012.
- [2] Anil Chacko and Samit Ari, "Denoising of ECG Signals using Empirical Mode Decomposition Based Technique", IEEE International Conference on Advances in Engineering, Science and Management (ICAESM), pp. 6 - 9, 2012.
- [3] Baby Paul, P. Mythili, "ECG Noise Removal using GA Tuned SignData Least Mean Square Algorithm", IEEE International Conference on Advanced Communication Control and Computing Technologies (ICACCCT), pp. 100 - 103, 2012.
- [4] Mohammed Assam Ouali and Kheireddine Chafaa, "SVD-Based Method for ECG Denoising", IEEE International Conference on Computer Applications Technology (ICCAT), pp. 1 - 4, 2013.
- [5] Lukas Smital, Martin Vitek, Jiri Kozumplik, and Ivo Provaznik, "Adaptive Wavelet Wiener Filtering of ECG Signals", IEEE Transactions On Biomedical Engineering, Volume 60, Issue 2, pp. 437 - 445, 2013.
- [6] Ali Marjaninejad, Farshad Almasganj and Ata Jodeiri Sheikhzadeh, "Online Signal to Noise Ratio Improvement of ECG Signal based on EEMD of Synchronized ECG Beats", IEEE 21th Iranian Conference on Biomedical Engineering (ICBME), pp. 113 - 118, 2014.
- [7] M.H. Moradi, M. Ashoori Rad and R. Baghbani Khezerloo, "ECG Signal Enhancement using Adaptive Kalman Filter and Signal Averaging", Elsevier Volume 173, Issue 3, pp. 553-555, 2015.
- [8] Julien Oster, Joachim Behar, Omid Sayadi, Shamim Nemati, Alistair E. W. Johnson, and Gari D. Clifford, "Semisupervised ECG Ventricular Beat Classification With Novelty Detection Based on Switching Kalman Filters", IEEE Transactions On Biomedical Engineering, Volume 62, Issue 9, pp. 2125 - 2134, 2015.

- [9] Khairul Azami Sidek, Ibrahim Khalil and Magdalena Smolen, "ECG Biometric Recognition in Different Physiological Conditions using Robust Normalized QRS Complexes" IEEE Computing in Cardiology, pp 97-100, 2012.
- [10] He Chen, Kuo-Kun Tseng, Fufu Zeng, Huang-Nan Huani and Shu-Vi Tu<sup>3</sup>, "A New ECG Identification with Neural Network", IEEE 12th International Conference on Hybrid Intelligent Systems, pp.427-430, 2012.
- [11] He Chen, Fufu Zeng, Kuo-Kun Tseng, Huang-Nan Huang, Shu-Yi Tu and Jeng-Shyang Pan, "ECG Human Identification with Statistical Support Vector Machines", IEEE International Conference on Computing, Measurement, Control and Sensor Network, pp. 237-240, 2012.
- [12] Maya Kallas, Clovis Francis, Lara Kanaan, Dalia Merheb, Paul Honeine and Hassan Amoud, "Multi-Class SVM Classification Combined with Kernel PCA Feature Extraction of ECG Signals", IEEE 19th International Conference on Telecommunications, pp. 1-5, 2012.
- [13] Laiali Almazaydeh, Khaled Elleithy and Miad Faezipour, "Obstructive Sleep Apnea Detection using SVM-Based Classification of ECG Signal Features", Annual International Conference of the IEEE Engineering in Medicine and Biology Society, pp. 4938 - 4941, 2012.
- [14] Yakup Kutlu and Damla Kuntalp, " Feature extraction for ECG heartbeats using higher orderstatistics of WPD coefficients", Elsevier Computer Methods and Programs in Biomedicine, Volume 105, Issue 3, pp. 257-267, 2012..
- [15] Carmen Camara, Pedro Peris-Lopez, and Juan E. Tapiador, "Human Identification using Compressed ECG Signals", Springer Journal of Medical Systems, pp. 1-18, 2015.