

# ENHANCEMENT OF POWER QUALITY USING DPFC

MAHESHWARI M<sup>1</sup>, C.R. SHARADA PRASAD<sup>2</sup>

<sup>1</sup>M.Tech Student, Department of EEE, UBDTCE Davangere, Karnataka, India

<sup>2</sup>Associate Professor in Department of EEE, UBDTCE Davangere, Karnataka, India

\*\*\*

**Abstract:-** In the earlier days power electronic were used to control and regulate the electrical quantities in power system. But, nowadays FACTs devices like UPFC, USSC, STATCOM, DSTATCOM are used to improve the power quality. In the present work, I have used a distributed power flow controller (DPFC) to improve the power quality issues like voltage sag, current swell, current and voltage profiles. This work explains the working of DPFC along with the controllers like PI controller, Fuzzy logic controller and ANN controller. The DPFC model is designed using MATLAB/SIMULINK software. The results are discussed for various types of controllers and are compared.

**Keywords:** Power quality, DPFC, Fuzzy logic controller, ANN controller, THD.

## 1. INTRODUCTION

An electric power system consists of electrical sections used to supply, transmit, and utilize electric power. An electrical structure can be widely separated into the generators that supply the power, the transmission system passes on the power from the creating centers to the load centers, and the appointment structure that feeds the ability to close-by homes and consumers. Electric power quality, or just control quality, includes voltage, frequency, and waveform. Power quality can be characterized as sustained supply voltage that stays inside the recommended range, enduring a.c frequency near the estimated worth, and smooth voltage waveform (takes after a sine wave). Power Quality can be characterized as the deviation of voltage, current and recurrence at the conveyance side. The disturbances occurred by the serious technical and financial problems for the devices. [1] The issues because of the poor power quality include Voltage Flicker, voltage sag, current swell, total harmonic distortion. Traditionally, fixed or mechanically switched shunt and series capacitors, reactors and synchronous generators were being used to solve much of the problem.[6]The poor power quality impacts the system parameters and moreover end customer sorts of apparatus. So to reimburse open power and to improve control quality FACTS devices are exhibited. These devices have high controllability in power system. The FACTs devices such as unified power flow controller(UPFC), synchronous static compensator (STATCOM) unified series shunt controller (USSC) are used to improve the power quality. The unified power flow controller which can transmit a real power in

bidirectional, it has ability to work in wide range of operating conditions and also regulates the DC voltage[4]. Currently It is a powerful device which can control the parameters like line impedance, transmission angle, and bus voltage etc. [7] The distributed power flow controller (DPFC) which is derived from the UPFC which provides high reliability, low cost, and high control capability as compared to the conventional FACTs devices.[2] In this work different controllers like PI, fuzzy logic and artificial neural network are used along with DPFC to mitigate the power quality issues by calculating total harmonic distortion for each case.

## 2. PRINCIPLE OPERATION

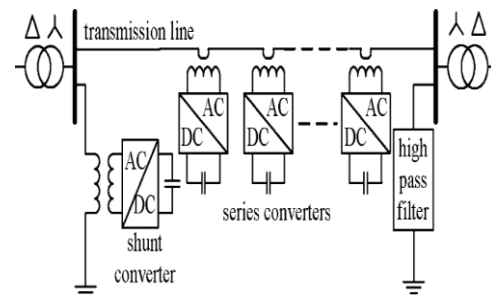

Figure 1: Block diagram of DPFC

As the DPFC is being used, that is to discard the use of tremendous size 3- $\phi$  course of action converter and use various minimal size 1- $\phi$  converters. The DPFC eliminates the common dc link between the shunt and series converters.[3] Every converter inside the DPFC is free and has its own one of a kind DC capacitor to give the required DC voltage Inside the DPFC, the transmission line demonstrates an average relationship between the AC ports of the shunt and the course of action converters. As such, it is possible to exchange dynamic power through the AC ports. The method relies upon power theory of non-sinusoidal parts. As demonstrated by the Fourier examination, non-sinusoidal voltage and current can be imparted as the total of sinusoidal limits in different frequencies with different amplitudes.

$$p = \sum_{i=1}^{\infty} V_i I_i \cos \phi_i,$$

Where  $V_i$  and  $I_i$  are the voltage and current at the fundamental frequency and  $\phi_i$  is the angle between the voltage and current at the same frequency. The above

equation shows the active power exchange at different frequencies. The shunt converter absorbs the active power at one frequency and generates the output at other frequency.[5] The power supply generates the active power at one frequency and shunt converter absorbs the active power, meanwhile the third harmonic subs stances in the Y- delta transformer. So the shunt converter injects the third harmonic current to the neutral point of the delta -Y transformer. Then the harmonic current flows through the transmission line. The harmonic current controls the DC voltage of the series capacitor thus the active power exchange takes place between the shunt and series converter in the DPFC.

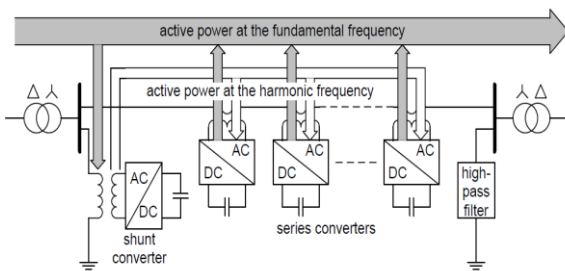

Fig 2. Active power exchange between the shunt and series converter.

Advantages of the DPFC system

- High Control Capability: The capacity to control all parameters of transmission sort out, for example, line impedance, transmission point, and transport voltage degree.
- High Reliability: in the event that one of the course of series converters comes up short, the others can keep working.
- Low cost: the course of series converters need not sit around idly with any high voltage segregation in transmission line Connecting; i.e., single turn transformers can be utilized to hang the plan converters.

3. SIMULATION

The simulation of the DPFC has been done by using MATLAB/SIMULINK arrangement. Inside the DPFC system the power source is connected to the nonlinear load through the transmission line. The series converter is connected (line 1) and shunt converter is connected (line 2) of the transmission line and ground through the Y-delta three phase transformer.

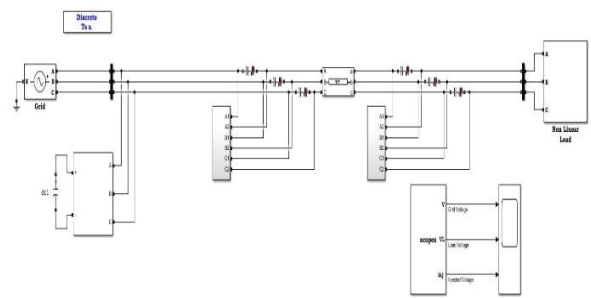

Fig 3: simulation model of the DPFC system.

➤ PI controller

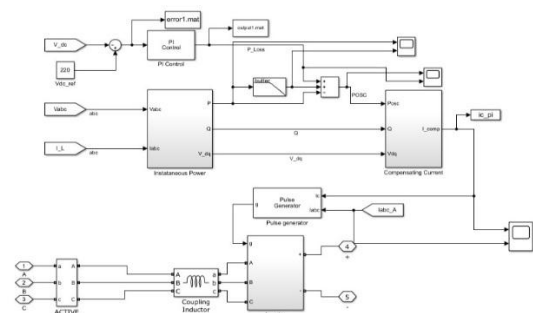

Fig 4: shows the PI controller

The PI controller utilized is of parallel sort in this where the estimation of P=0.2 and I=1.5 individually. This is the least controller used to tune the sign through them. The vast majority of the enterprises use PI controllers as these are viewed as the most effortless and effectively implantable.

➤ Fuzzy logic controller

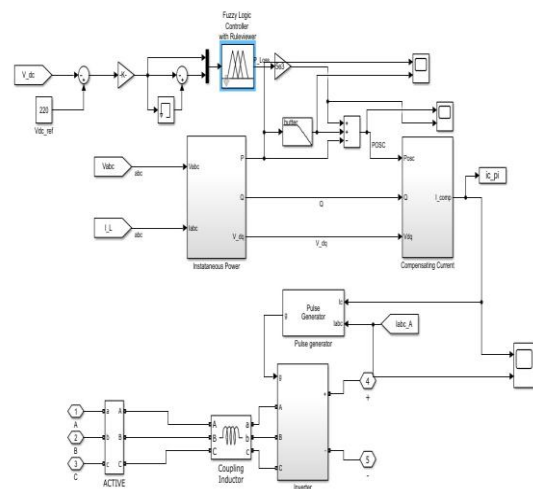

Fig 5: shows the fuzzy logic controller.

The fluffy rationale controller will have some range fixed by the client for tuning reason. The sign are intended to

be gone through that for legitimate tuning reasons for the sign. The figure appeared here speaks to the fluffy rationale controller which creates the ability to the framework by taking in the DC voltage reference and the genuine DC voltage from the Shunt converter.

➤ **Artificial neural network controller**

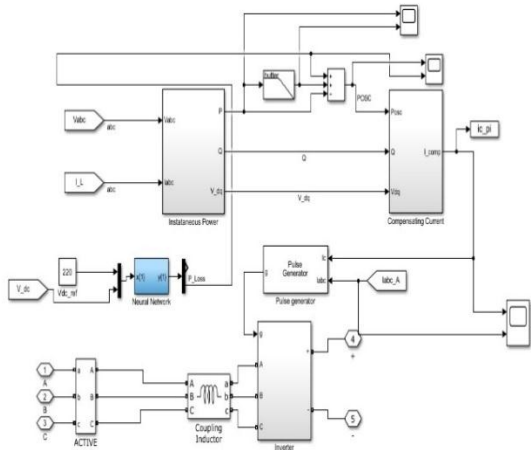

Fig 6: shows the Artificial neural network.

In ANN controller appeared in figure it takes the genuine and reference DC voltage to produce the power which is utilized to create the entryway heartbeats to shunt converter. The ANN controller comprises of layers of tuners for tuning reason. Thus of everything, the ANN controller is viewed as the best as this have layers of channels.

**4. Simulation results and discussion**

From the system simulated, the results have been obtained for all the methods. The fig: 7 represents the grid voltage, load voltage and the injected voltage for without DPFC system.

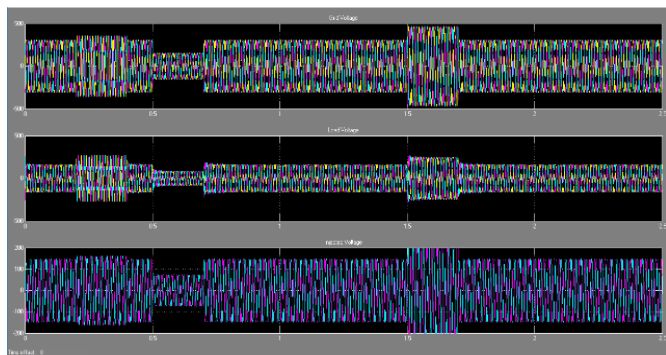

Fig 7: Grid voltage Load voltage and injected voltage without DPFC

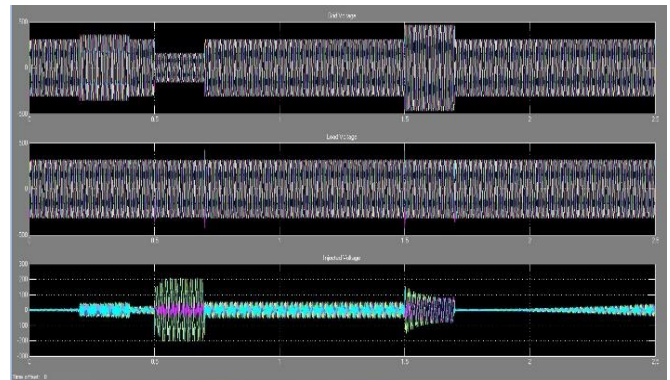

Fig 8: PI controller grid voltage, Load voltage and Injected voltage.

The Load voltage at all the time must be kept steady with the goal that it will be same in every one of the situations appeared in figure 8. The framework voltage any place it turns out to be low, the voltage/current is infused as appeared in third piece of figure 8. The infused voltage repays the network voltage in order to keep the voltage consistent.

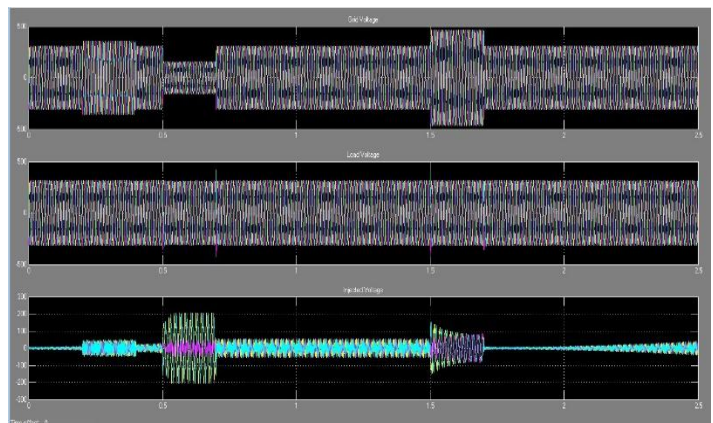

Fig 9 : Fuzzy Logic Controller grid voltage, Load Voltage and Injected voltage

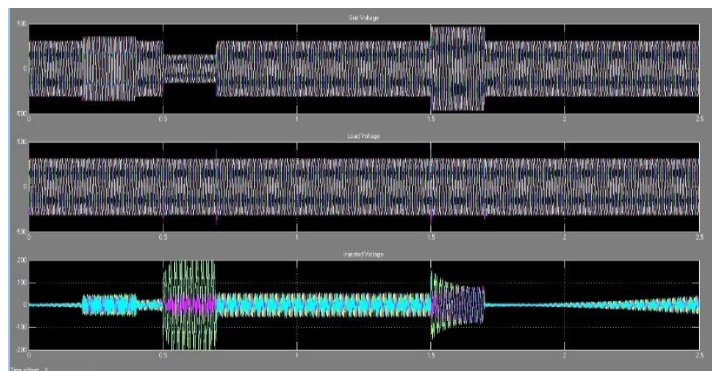

Fig 10:ANN controller grid voltage, load voltage and injected voltage.

The ANN method which is Artificial Neural Network will have layers of tuning for the signals. These give best results compared to everything as this is used for high level of projects.

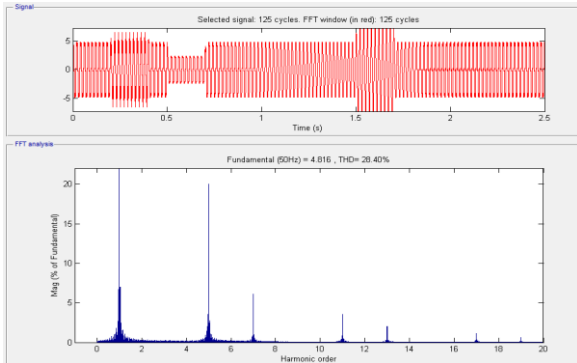

Fig 11: (a) Total harmonic distortion of grid voltage without DPFC

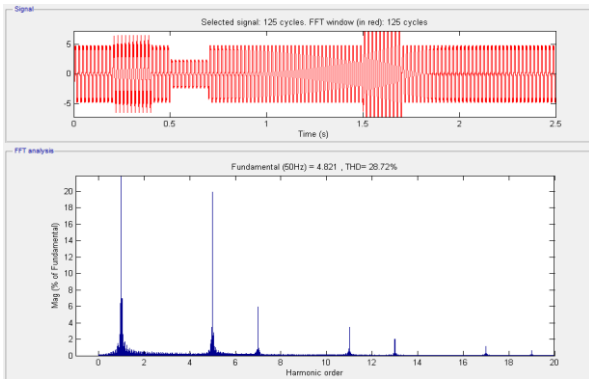

Fig: 11(b) Total harmonic distortion of load voltage without DPFC

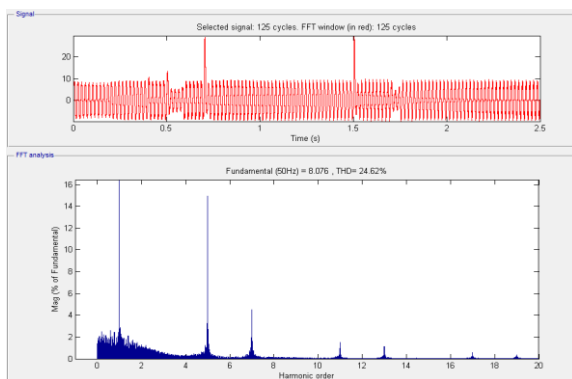

Fig : 12 (a) Total harmonic distortion of grid voltage with PI controller

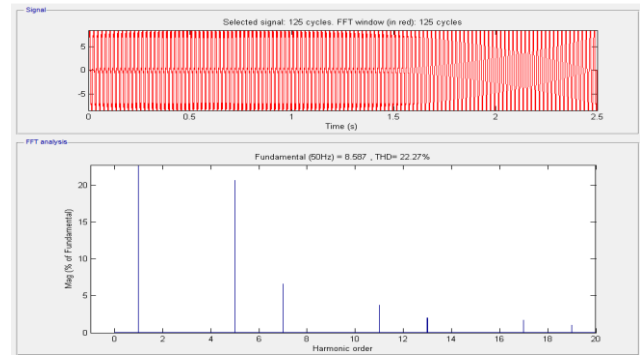

Fig 12: (b) Total harmonic distortion of load voltage with PI controller

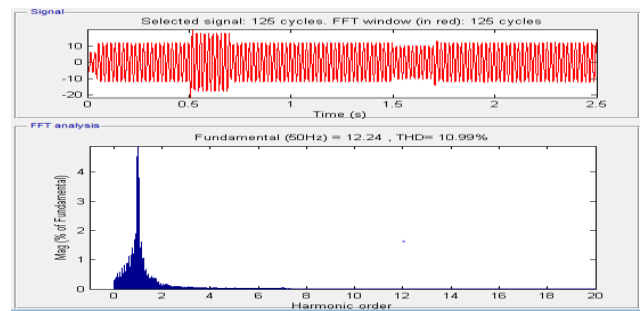

Fig 13: (a) Total harmonic distortion of grid voltage with fuzzy logic controller

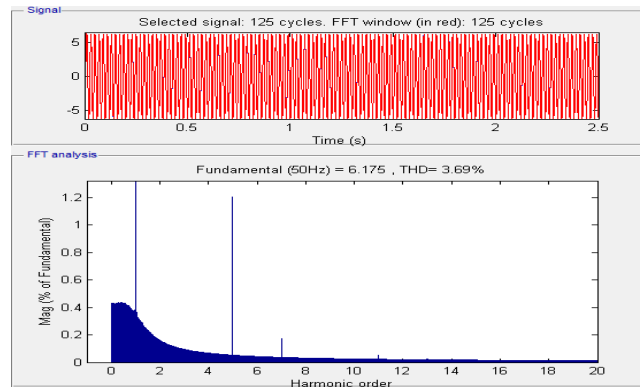

Fig 13: (b) Total harmonic distortion of load voltage with fuzzy logic controller

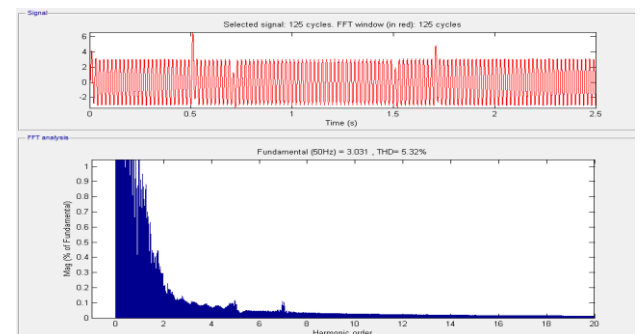

Fig 14: (a) Total harmonic distortion of grid voltage with Artificial neural network



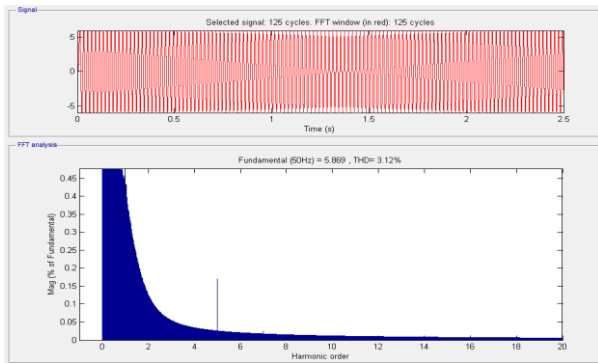

Fig 14 :(b) Total harmonic distortion of load voltage with Artificial neural network

Table 1: Harmonic distortion

Sl.no	Total harmonic distortion	Total harmonic distortion	
		Grid voltage	Load voltage
01	Without DPFC	28.40%	28.72%
02	DPFC with PI controller	24.62%	22.27%
03	DPFC with Fuzzy logic controller	10.99%	3.69%
04	DPFC with Artificial neural network controller	5.32%	3.12%

The Total Harmonic Distortion (THD) plays a significant role while comparing the results of the controller. The above comparison table represents the both grid voltages as well as the Load voltages THD in FFT analysis of the MATLAB/Simulink. The THD is found to be less in ANN controller when compared to the other two controllers. So it is considered as more accurate and efficient method for improving the power quality

## 5. CONCLUSION

It is very important to improve the power quality of a system. In the present work simulations are done to obtain grid voltage and load voltage profiles with and without DPFC. The voltage waveforms are obtained for DPFC with PI controller, Fuzzy logic controller and ANN controller. The results are quantified by calculating the total harmonic distortion in each case. It is very clear that DPFC with artificial neural network is superior compared to DPFC with PI or Fuzzy logic controllers.

## 6. REFERENCES

- [1] Abinash and Shrikant Singh “An Analysis of the of Power Quality” International Journal of Advanced Research in Electrical, Electronics and Instrumentation Engineering (An ISO 3297: 2007 Certified Organization) Website: www.ijareeie.com Vol. 6, Issue 4, April 2017.
- [2] Janardhan and Y.N Vijayakumar “Power quality improvement using distributed power flow controller” International Journal of Latest Engineering and Management Research (IJLEMR) ISSN: 2455-4847 www.ijlemer.com || REETA-2K16 || PP. 425-433.
- [3] P. Penchalamma, Dr P. Ramesh, Dr. S. Suresh Reddy. “Power Quality Improvement using DPFC with PI and Fuzzy Logic Controller”. International journal of scientific engineering and technology research, ISSN 2319-8885 Vol.06, Issue.31 October-2017, Pages: 5932-5936.
- [4] S. Ashok kumar and N. Visali” Improvement of Power Quality by Using DPFC” International Journal of Emerging Technology in Computer Science & Electronics (IJETCSE) ISSN: 0976-1353 Volume 12 Issue 2 –JANUARY 2015.
- [5] Ahmad Jamshidi, S. Masoud Barakati, and M. Moradi Ghahderijani” Impact of Distributed Power Flow Controller to Improve Power Quality Based on Synchronous Reference Frame Method” IACSIT International Journal of Engineering and Technology, Vol. 4, No. 5, October 2012
- [6] Naresh Acharya and Arthit Sode-Yome “Facts about Flexible AC Transmission Systems (FACTS) Controllers: Practical Installations and Benefits”.
- [7] Vikash Kumar Goutam and Dr. Deependra Singh” Voltage Sag and Harmonics Mitigation Using Distributed Power Flow Controller “International Research Journal of Engineering and Technology (IRJET) Volume: 04 Issue: 08 | Aug -2017