

Effects of Over Sizing of a Centrifugal Pump

Pritam Kumar¹, Rajkumar Dhakad², Ms. Farhin Khan³ Mrs. Samatha Singh⁴

^{1,2}Student, Department of Chemical Engineering, Indore Institute of Science & Technology, Indore

³Assistant Professor, Department of Chemical Engineering, Indore Institute of Science & Technology, Indore

⁴Head, Department of Chemical Engineering, Indore Institute of Science & Technology, Indore

Abstract - This paper describes the effects of oversizing a centrifugal pump by using AFT Fathom. Here we will analyze and discuss the problem of pump sizing and line sizing. The pumps are used to force gas and liquid to go in a particular direction, which increases the discharge pressure or head of the pump. Centrifugal pumps are widely used in the industry, especially within the oil and gas sector for fluids transport. At high flow rates and relatively low pressures, these pumps are designed to move single-phase fluids. The parts of centrifugal pumps are casing, impeller, suction pipe with a foot valve and a delivery pipe, strainer, etc. Sizing a pump or line using AFT Fathom is incredibly easy. However, a very helpful assumption to keep in mind is that all pipes are presumed to be liquid full in AFT Fathom. To size a pump for a system that is already liquid full and all you have to design a pump with a fixed flow rate then let, AFT Fathom determine how much pressure drop system has and also determine how much pump head is needed to overcome elevation changes and system resistance. After that, we have got our head rise generated, an operating point that we need to find a pump curve that will match, and also our flow rate. At process plants, centrifugal pump systems with flow throttled by a control valve are ubiquitous. Unfortunately, most pumps are oversized, all of which pose controllability problems and waste energy issues. For two big causes, pump oversizing happens. First, using calculations for pipework and its fittings, a system's pressure drop must be determined very early in the planning. Unfortunately, values taken from the literature, such as coefficients of valve flow resistance, can vary widely. Dynamic pressure losses are, therefore, somewhat shaky. Differences in static pressure are typically best defined. Thus, certain safety margins must be applied by planning engineers. When pipework has been constructed, fixing a pressure drop measurement much later does not fix this problem. The rated flow may also have some margin applied. Second, the manufacturer of the pump also adds safety margins to ensure that the pump meets guaranteed performance, particularly if the water is not the liquid treated. So, preventing the construction of oversized pumps is almost difficult. Therefore, adjusting a pump based on experiences until the plant is operational is the only realistic option.

Keywords: Line sizing, Pump sizing, Over sizing, Pump characteristic curve, AFT Fathom, Under sizing.

1. INTRODUCTION

A pump is a mechanical device that raises liquid from a low to a high level or flows liquid from a low-pressure level. Area to high pressure. Pumps that require high hydraulic pressure can also be used in process operations. This can be seen in equipment for heavy duty use. High discharge pressure and low suction pressure are usually needed for heavy duty equipment [1]. The fluid will rise from a certain depth due to low pressure at the suction side of the pump, while it will force fluid to rise until the desired height is reached due to high pressure at the discharge side of the pump. Centrifugal pumps are the most common and commonly used form of pump for trans-feeding [3]. In simple terms, it is a pump that uses a revolving impeller to move water or other fluids using centrifugal force. These are the undisputed pump choices, particularly for the transmission of liquid from one place to another in a wide range of industries, including pharmaceutical, agricultural, wastewater, industrial, power generation, industrial and power generation plants, mining, chemical, petroleum, and many others [6]. Centrifugal pumps are used to cause flow or to lift the liquid from a low to a high level. These pumps are operating on a very basic mechanism [2]. The centrifugal pump converts rotary energy, often from a motor, to energy in a moving fluid. The two main parts of the pump that are responsible for the conversion of energy are the casing and the impeller [5]. The impeller is the revolving component of the pump and the casing is the airtight passage that surrounds the impeller. In a centrifugal pump, the fluid enters the casing, falls on the impeller blades in the impeller's eye, and is whirled outward tangentially and radially before the impeller blades are raised leaves the impeller in the diffuser portion of the casing. When fluid is passing through the impeller, the fluid is gaining both velocity and pressure [12].

1.1 Pump sizing and line sizing

The chemical process industry is engaged in a wide variety of activities, for various types of fluids, with different applications [7]. While, in practice, there are various standards and formulas available for pipe sizes for different services. It is therefore important to be critical at times of conceptualization before determining the design parameters. As fluids have to be moved from

one location to another in household pipes to cross-country pipelines, pipes and fittings are a high expense. The size of the pipe plays an important role in pumping costs [18].

1.1.1 line Sizing

Various fluid types are used in various forms in any chemical process industry, such as liquid, gaseous, slurry etc. For the following purposes, raw materials, intermediate goods or finished products manufactured by different unit operations need the connection of all units with pipelines and fittings: fast operation, safe handling of materials, preventing material loss, hygienic plant conditions.

1.1.2 Pump size

The head of the system is the amount of pressure required in the system downstream of the pump to achieve a specified flow rate [14]. The system head is not a fixed quantity-the faster the liquid flows, the higher (for reasons to be addressed later) the system head becomes. However, in order to demonstrate the relationship between flow and hydraulic resistance for a given system, a curve, known as the system curve, can be drawn. Pump sizing, then, is the specification of the necessary outlet pressure of a rotodynamic pump with a given system head (which varies nonlinearly with flow) (whose outlet flow varies nonlinearly with pressure) [16].

1.2 Pump Characteristics curve

Head pressure on the vertical y-axis and a pump curve signifies flow on the horizontal x-axis. The curve also shows the head shut off or the head that would be created by the pump if it worked against a closed valve. Efficiency curves are also given by the pump efficiency curve. The head-flow curves intersect with these performance curves and are labelled with percentages. The Best Efficiency Point can also be marked by certain curves. This is the point on the performance curve of a pump that corresponds to the maximum efficiency and is typically about 80-85 percent of the shutoff head [15].

1.3 Cases of pump sizing

The primary purpose is usually to obtain the necessary pressure and flow for the application when choosing a pump and piping system, whether this is a cooling water system, gasoline pipeline, chemical processing plant or one or several other applications [8].

1.3.1 Under sizing

A lower flow rate than required would be achieved in the system if the pump chosen is undersized in terms of

power [10]. This would either include new pumps, such as opening discharge valves and inserting recirculation pipes, or improvements to the system [11].

1.3.2 Over sizing

An oversized pump can give more flow than the machine needs. It may be appropriate to minimize flow with a throttling valve, or by trimming the impeller, depending on the application [4]. It can seem to have no impact on the system in situations where the pump operating point can be corrected by easily adjusting valves in the system. However, when considering the efficiency of the pump, the consequences of oversizing or undersizing the pump are more obvious [13].

Various tests have found that there are multiple overweight process pumps [9]. Optimizing over-sized pumping systems can save significant quantities of energy by reducing pump friction and extending bearing, seal and impeller life, as well as impacting pump efficiency. Oversized pumps will run on the pump curve to the left of the best efficiency point (BEP), causing massive internal recirculation, low-flow cavitation, and high shaft loads [19]. There are several possible ways to overcome the state of an oversized pump and device, including the following:

- Install another pump.
- Modify the control solution to provide a recirculation line for flow.
- Trimming the impeller.
- Install a variable frequency drive (VFD) and pump speed reduction [18].

Case 1: (case of actual sizing) A pump must be used to move water from a supply reservoir to a storage reservoir at the top of a mountain. A supply reservoir, a pump, a discharge tank, and two pipes make up the system. The first pipe (P1) from the supply reservoir to the pump is 30 feet long, and the second pipe (P2) leading from the pump to the discharge reservoir is 970 feet long. Both of the pipes are Steel - ANSI, 4-inch, STD (schedule 40). Constant properties of fluids are assumed. The surface pressure of the supply reservoir is 0 psig and the liquid surface is at a height of 15 feet. The discharge reservoir has a surface pressure of 0 psig, and the liquid surface is at a height of 266 feet. The pipes for both of the reservoirs connect to the reservoirs at a depth of 10 feet. What is the head requirement in this system at 500 gal / min for a pump to supply flow?

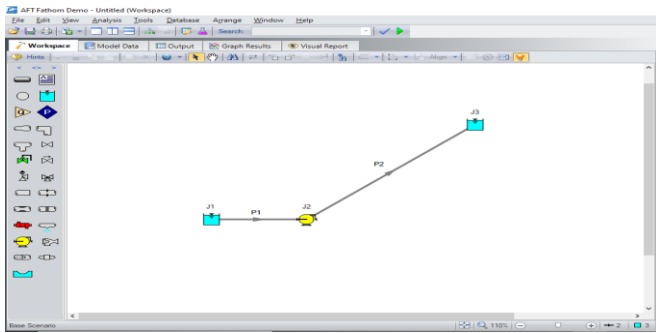

Fig -1: Process Flow sheet of the given module.

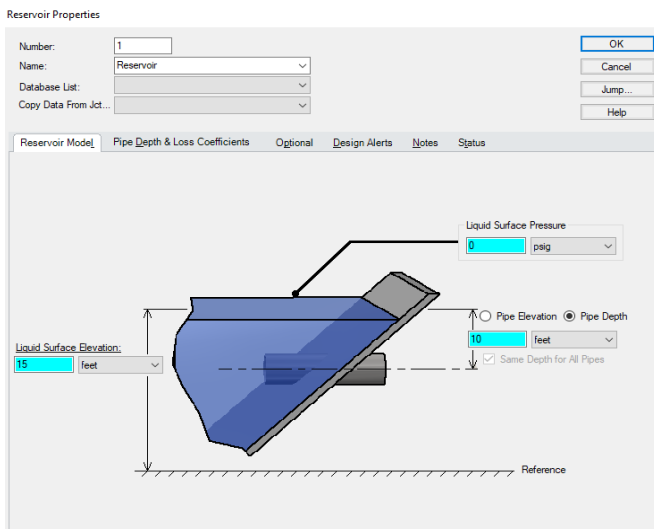

Fig- 2: Properties window for Reservoir J1.

Pump Configuration

Configuration Method: Simple Multiple

Pump Data Configuration Data Performance Graph

Raw Data:

Parameter	Flow Q	Head/Pressure dh	NPSHR	Efficiency/Power
Units	gal/min	feet	feet	Percent
1	0	400		
2	500	380.55		
3	1000	250		
4				
5				
6				
7				
8				
9				
10				
11				
12				
13				
14				

Curve Fitting: Curve Fit Type: Polynomial Interpolated X-Y Data Head Rise NPSHR Efficiency

Curve Fit Order: 2

Generate Curve Fit Now

PUMP CURVE

a: 400
b: 0.07219995
c: -0.002221999

EFFICIENCY: None

Equation: $\Delta H = a + bQ + cQ^2 + dQ^3 + eQ^4$

Fig- 3: The Pump Sizing Parameter should be set at pump curve data.

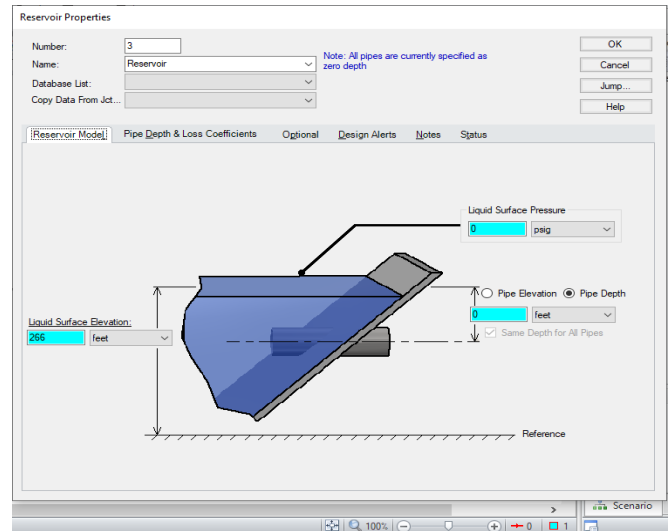

Fig- 4: Properties window for Reservoir J3.

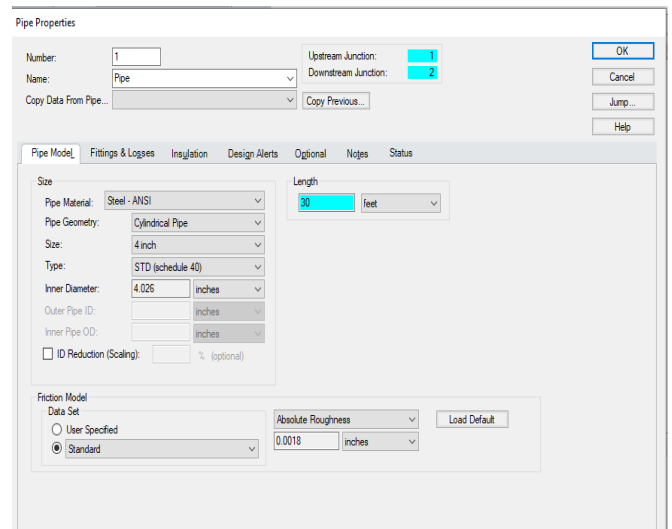

Fig-5: Properties window for Pipe P1.

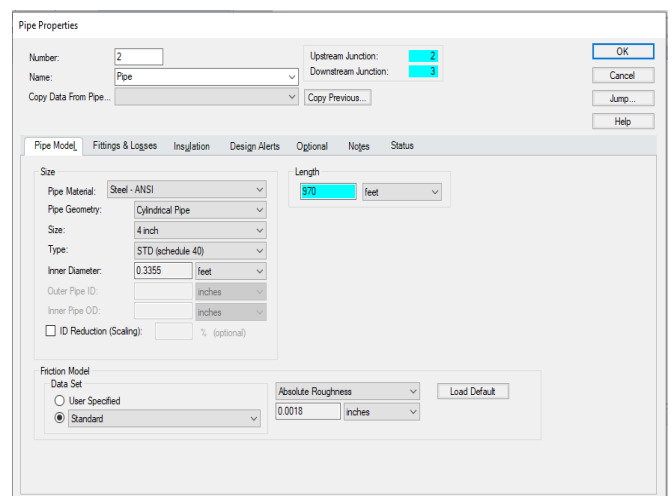

Fig- 6: Properties window for Pipe P2.

Case 2: (case of over sizing) A pump must be used to move water from a supply reservoir to a storage reservoir at the top of a mountain. A supply reservoir, a pump, a discharge tank, control valve and two pipes make up the system. The first pipe (P1) from the supply reservoir to the pump is 30 feet long, and the second pipe (P2) leading from the pump to the discharge reservoir is 970 feet long. Both of the pipes are Steel - ANSI, 4-inch, STD (schedule 40). Constant properties of fluids are assumed. The surface pressure of the supply reservoir is 0 psig and the liquid surface is at a height of 15 feet. The discharge reservoir has a surface pressure of 0 psig, and the liquid surface is at a height of 266 feet. The pipes for both of the reservoirs connect to the reservoirs at a depth of 10 feet. What is the head requirement in this system using control valve flow is control 500 gal / min for a pump to supply flow?

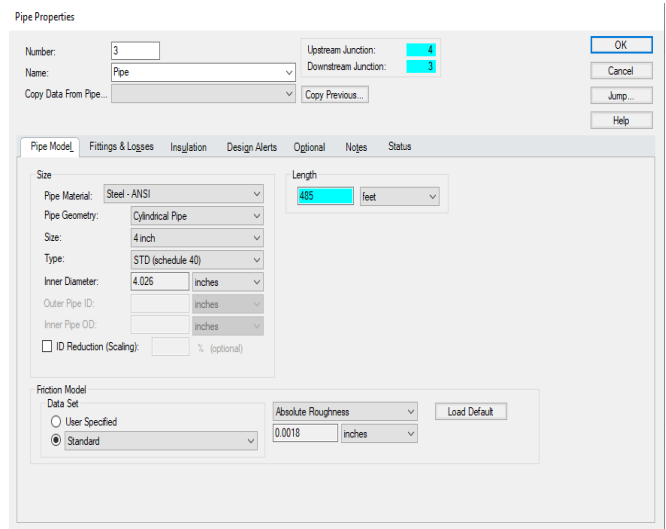

Fig- 9: Properties window for Pipe P3.

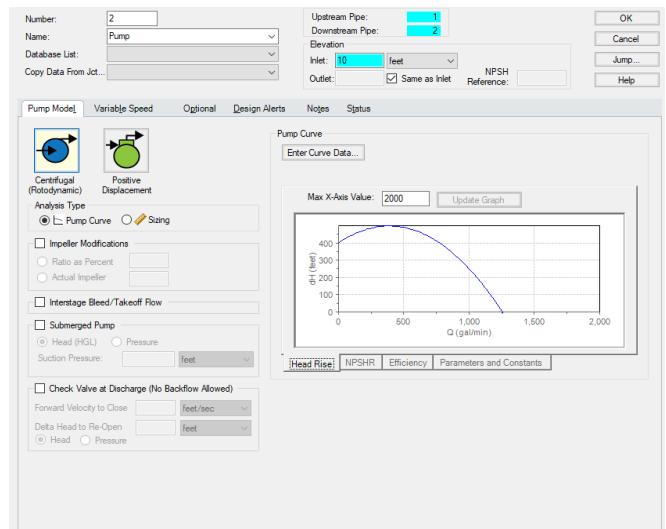

Fig- 10: Properties window for Pump junction J2.

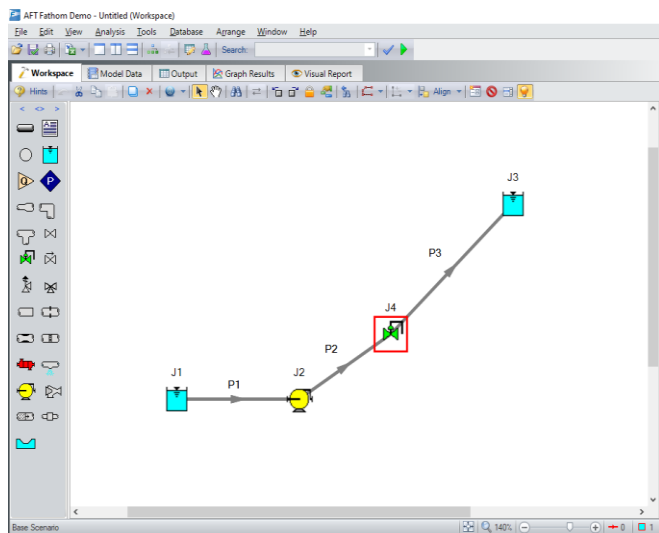

Fig- 7: Process Flow sheet of the given module.

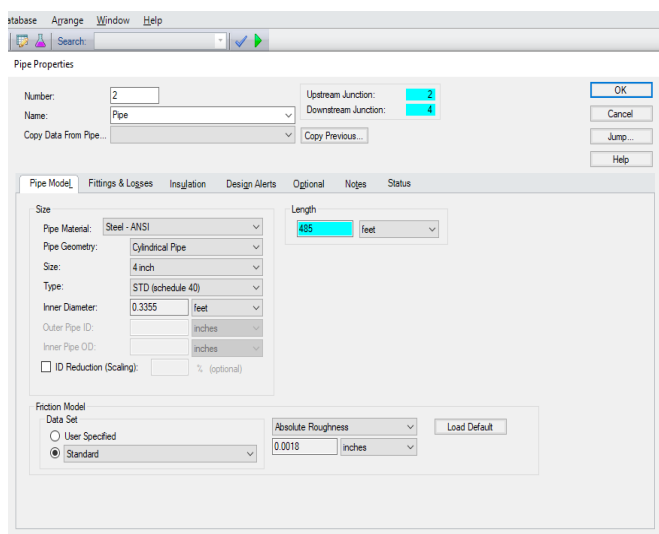

Fig- 8: Properties window for Pipe P2.

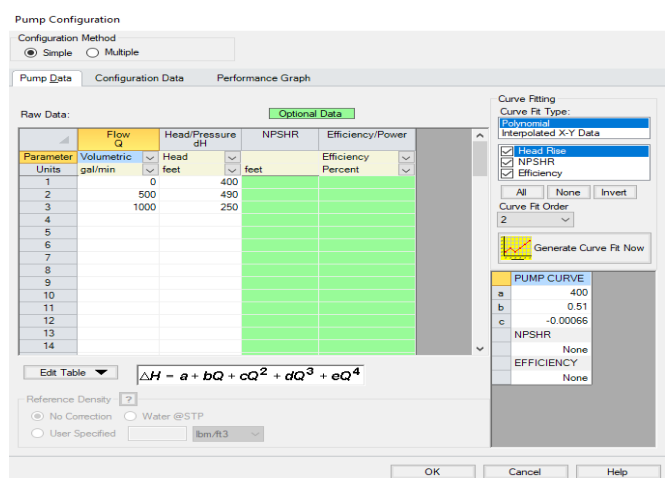

Fig- 11: The Pump Sizing Parameter.

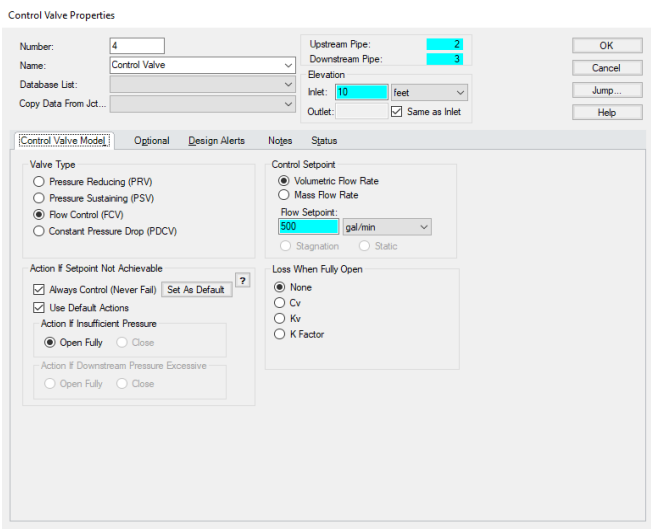

Fig- 12: Properties window for Pump junction J4.

2. RESULT

The Pump summary indicates that the head requirement of the pump is 380.4 feet for this system. The difference in reservoir elevation is 266 feet, so this is the minimum head raise required regardless of the flow rate or pipe size. The loss of friction is about 134 feet as well. This can be seen in the dH column of the Pipe output pane. (For Case 1, Figure 14). The Pump summary show that the head requirement of the pump is 490.0 feet for this system. The difference in reservoir elevation is 266 feet, so this is the minimum head raise needed regardless of the flow rate or pipe size. The loss of friction is about 128 feet as well. This can be seen in the Pipe output window's dH column. (Regarding case 2, Figure 17).

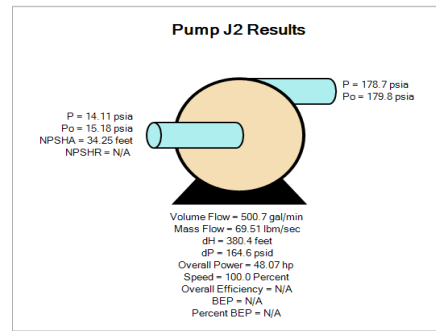

Fig- 14: Pump result diagram as opened from the pump summary (for case 1)

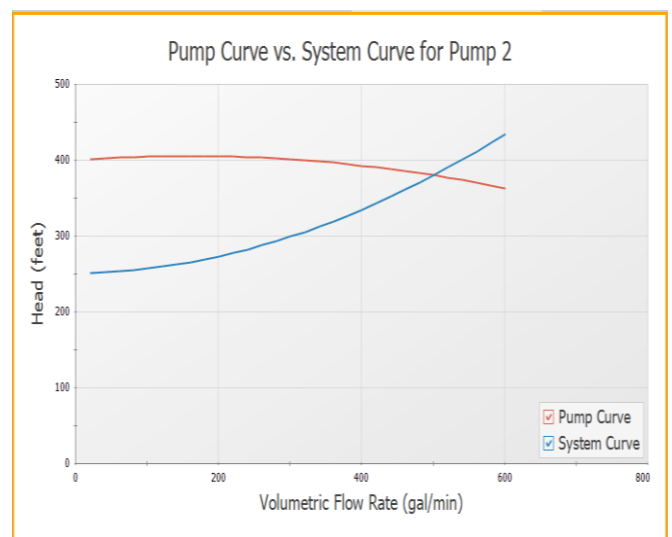

Fig- 15: Pump vs. System curve using selected pump (for case 1)

Jct	Results Diagram	Name	Vol. Flow (gal/min)	Mass Flow (lbm/sec)	dP (psid)	dH (feet)	Overall Efficiency (Percent)	Speed (Percent)	Overall Power (hp)	BEP (gal/min)	% of BEP (Percent)	NPSHA (feet)	NPSHR (feet)
2	Show	Pump	500.7	69.51	164.6	380.4	N/A	100.0	48.07	N/A	N/A	34.25	N/A

Pipe	Name	Vol. Flow Rate (gal/min)	Velocity (feet/sec)	P. Static Max (psia)	P. Static Min (psia)	Elevation Inlet (feet)	Elevation Outlet (feet)	dP Stag Total (psid)	dP Gravity Total (psid)	dH (feet)	P. Static In (psia)	P. Static Out (psia)	P. Stag In (psia)	P. Stag Out (psia)
1	Pipe	500.7	12.62	17.95	14.11	5.000	10.000	3.843	3.843	2.163	3.880	17.95	14.11	19.02
2	Pipe	500.7	12.62	178.73	13.63	10.000	266.000	165.101	110.771	125.562	178.73	13.63	179.80	14.70

Fig-13: Output window for (case 1)

Pipe	Name	Vol. Flow Rate (gal/min)	Velocity (feet/sec)	P. Static Max (psia)	P. Static Min (psia)	Elevation Inlet (feet)	Elevation Outlet (feet)	dP Stag Total (psid)	dP Gravity Total (psid)	dH (feet)	P. Static In (psia)	P. Static Out (psia)	P. Stag In (psia)	P. Stag Out (psia)
1	Pipe	500.0	12.60	17.95	14.12	5.000	10.000	3.838	3.838	2.163	3.870	17.95	14.12	19.02
2	Pipe	500.0	12.60	226.14	159.07	10.000	10.000	27.069	27.069	0.000	62.565	226.14	159.07	227.21
3	Pipe	500.0	12.60	151.47	13.63	10.000	266.000	137.840	137.840	110.771	62.565	151.47	13.63	152.54

Jct	Name	P. Static In (psia)	P. Static Out (psia)	P. Stag In (psia)	P. Stag Out (psia)	Vol. Flow Rate Thru Jct (gal/min)	Mass Flow Rate Thru Jct (lbm/sec)	Loss Factor (K)
1	Reservoir	14.70	19.02	14.70	19.02	500.0	69.51	0
2	Pump	14.12	226.14	15.19	227.21	500.0	69.41	0.00
3	Reservoir	14.70	14.70	14.70	14.70	500.0	69.41	0.00
4	Control Valve	199.07	151.47	200.14	152.54	500.0	69.41	44.58

Fig- 16: Output window for (case 2).

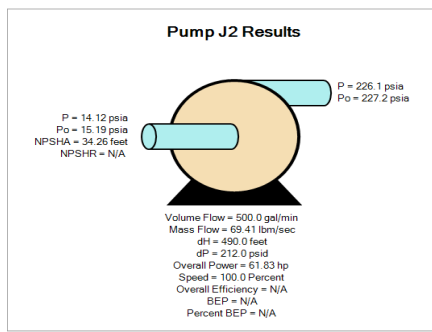

Fig- 17: Pump result diagram as opened from the pump summary (for case 2)

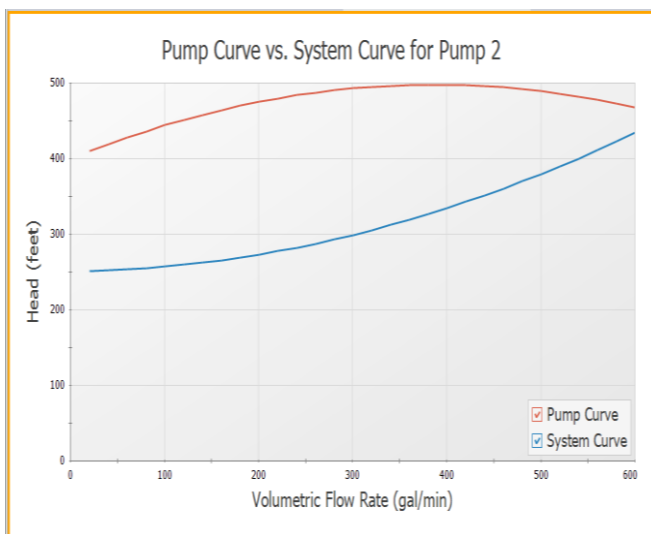

Fig- 18: Pump vs. System curve using selected pump. (for case 2)

3. CONCLUSION

The primary purpose is usually to produce the required pressure and flow for the application while choosing a pump and piping system, whether this is a cooling water system, fuel pipeline, chemical manufacturing plant, or one of several other applications. To determine the total dynamic head at the pump, which is then used to evaluate pump curves for potential pumps, the appropriate flow rate for the system is used. Oversizing or Undersizing a pump will have a significant effect on the system, which is why it is important to use an accurate operation point for this operation. If the specified pump is undersized in terms of power, the system would produce a lower flow rate than necessary. The head requirement of the pump is 380.4 feet in this paper (for case 1). The difference in reservoir elevation is 266 feet, so this is the minimum head raise required regardless of the flow rate or pipe size. The loss of friction is also approximately 134 feet. This can be seen in the dh column of the output window of the pipe. (In case 2), the Pump Description indicates that the pump's

head requirement is 490.0 feet for this system. The difference in reservoir elevation is 266 feet, so this is the minimum head raise needed regardless of the flow rate or size of the pipe.

REFERENCES

- [1] Bloch, H., and Budris, A., "Pump User's Handbook: Life Extension," 3rd ed., Fairmont Press, Lilburn, Ga. (2010).
- [2] Centrifugal Pumps for Petroleum, Petrochemical and Natural Gas Industries," API Standard 610, 11th Ed., Amer. Petroleum Inst., Washington, DC (2010).
- [3] Genić, S., et al., (June 2011). "A Review of Explicit Approximations of Colebrook's Equation," FME Transactions, 39, pp. 67–71.
- [4] Hydraulic Institute, "Trimming or Replacing Impellers on Oversized Pumps," pp. 38–39, World Pumps, April 2009.
- [5] James Thomson (Dec. 23, 1859). "Professor Thomson's Centrifugal Pump". The Mechanics' magazine, and journal of engineering, agricultural machinery, manufactures and shipbuilding (Robertson, Brooman, & Co.) II: 408–410
- [6] John Richards (1894). Centrifugal pumps: an essay on their construction and operation, and some account of the origin and development in this and other countries (<http://books.google.com/books?id=013VAAAAMA-AJ&pg=PA41>). The Industrial Publishing Company.p. 40–41.
- [7] Karassik, I, Messina, J., Cooper, P., and Heald, C., "Pump Handbook," 4th ed., McGraw Hill, New York (2008).
- [8] Larry Bachus, Angle Custodio (2003). Know and understand centrifugal pumps. Elsevier Ltd.
- [9] Mackay, R., "The Practical Pumping Handbook," Elsevier, Waltham, Mass. (2004).
- [10] McCarty, M., "Properly Size Control Valves," pp. 21–25, Chemical Processing, January 2015
- [11] McNally, W., "Centrifugal Pump & Mechanical Seals Manual," McNally Institute, Dade City, Fla. (2008).
- [12] Moran, S., (2015) "An Applied Guide to Process and Plant Design," Butterworth-Heinemann Oxford, U.K.
- [13] Perry, R. H., and Green, D. W., "Perry's (2007) Chemical Engineers' Handbook," 8th Ed., McGraw-Hill, New York, NY.
- [14] Schicketanz, W., "Reducing Avoidable Pressure Loss," pp. 18–21, World Pumps, January 2011.
- [15] W. Ding and J. Wen, (1997) "Pump Renovation of Jinagsu Liulaojian Pump station," Drainage and irrigation Machinery, vol. 1.
- [16] W.-L. Chuang, S.-C. Hsiao, and K.-S. Hwang, (2014) "Numerical and Experimental Study of Pump Sump Flows," Mathematical Problems in Engineering, vol. 2014, Article ID 735416, 20 pages.
- [17] <https://www.aft.com/products/fathom>

[18] <https://www.aft.com/learning-center/application-topics>

[19] <https://www.pumpsandsystems.com/effects-oversizing-or-undersizing-pump>

Author Profile.



Pritam kumar is UG student, Department of Chemical Engineering, Indore Institute of Science and Technology, Indore