

CAR DOOR CONTROL BASED ON NEARBY APPROACHING OF OBJECTS

A Rajadattu¹ D R Raghavendra Rao² S Mahesh Kumar Reddy³ Dr G Ganesh Kumar⁴

^{1,2,3}Sreenidhi Institute of Science and Technology, Ghatkesar

⁴Assistant Professor, Dept. of Electronics and Communication Engineering, Sreenidhi Institute of Science and Technology College, Telangana, India

Abstract - There has been a lot of development in each and every aspect in automobile industry. Although, there are few problems left even in recently released technologically updated cars. We are taking up one of these problems as a challenge and try to build a prototype depicting the solution. The problem is that whenever a person gets down from the car, he/she might not check the vehicles or anything coming from rear which sometimes lead to accident. We come across these situations frequently. Be it the situation where the person parks and gets down from the car or the situation where person stops the car aside the road, these incidents might happen. We take this as a lead and build a prototype in such a way that the doors will be locked if any vehicle or person or any other object passes by the sides and unlocked if no object passes by with the help of sensors on front and back. The main aim of this project is to ensure that person who gets down from the car needs to get to know if any vehicle or person or object is passing from that side. If so, car door should be locked and if nothing passes, car door should be unlocked. This can be applied to four doors. Our prototype contains the mentioned feature. A 3d printed car with two doors shall be used to represent the prototype.

Keywords: Car door, Open, Lock, Unlock, Feature

1. INTRODUCTION

The main objective of this project is that, be it any of the four doors of a car (can be applied to autos, small trucks), whenever a vehicle (be it two wheeler, four wheeler, bicycle), roller-blader, or a walking or a running person tries to pass a car from any side, the doors on that side of the car should be locked and should not be unlocked until the vehicles crosses the car completely. This mechanism holds good for any kind of situation which includes a car parked completely or a car in the middle of the traffic. In the figure 1, luckily, the person from first car is not getting down by the time the other car has been hitting it. If there is also person aside the opened door, the car would have hit that person along with the door. At such speed, forget about the door, the person would have been severely injured or might have died. To avoid such incidents, we need to be very careful while getting down from the car, otherwise, we need a prototype like automatic car door locker when a vehicle passes by. That is why, we gave a thought and are implementing this idea.



Fig-1: Car Doring

In the figure 2, the rider on a bike [2] is trying to pass by a car very close and person in a car is getting down at the same time the rider passing by. There will be sure shot damage to both the vehicles and injuries to both the persons depending upon the speed of the rider.



Fig-2: Bike Doring

In the figure 3, the person riding the cycle [3] rode into the door of a car which was just parked and hit it. The rider was saved by using the helmet however. In some cases, the person riding into the car door alone gets affected. The person riding into the car door along with the person in the car gets affected combinedly. If a car

runs into another car door, only the person in the car which is being hit gets affected.



Fig-3: Bicycle Dooring

In the figure 4, a roller blader[4] gets doored while he passes by a car. These incidents happen regularly. No one will be spared if we do not have proper mechanism inside a car.



Fig-4: Roller-blader Dooring

2. LITERATURE SURVEY

In order to prevent accidents due to the carelessness of people, this model [1] is used to control car door locks automatically using distance measuring system, child lock and ultrasonic sensors. So that people inside car cannot open the door while object moves towards the car. If any object appears near the car, the signals get reflected and received by the receiver. Now,

microcontroller sends signal to child lock and gets activated according to the code dumped. Thereafter the car doors associated with the child lock gets locked.

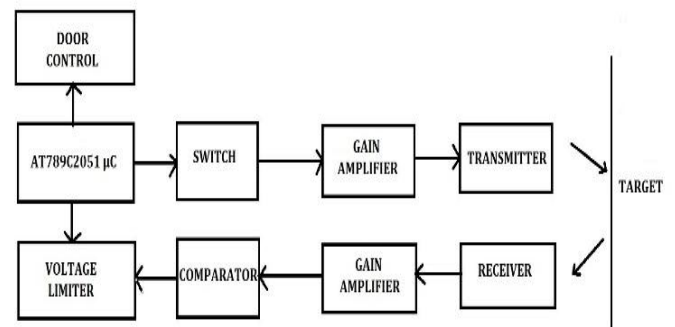

Fig-5: Safety Locking System of Car Door Using Sensors

First of all, this model which is shown in figure 2.1.1 has the same idea as that of our project but the we can spot the difference in implementation of the idea. The locking is specified with the child lock only. The fact about child lock is that this child lock is being installed in almost every car which gets manufactured but will be provided only for rear doors. And the feature of child lock for rear doors have been stopped from July,2019 as this feature have been misused by the drivers towards women in cab services such as Ola, Uber. The microcontroller used is also a bit older one. So, this model cannot be used if at it is implemented because we require control at all doors. This is the reason we tried to implement our idea which has capability to control the locks of all the doors of the car.

3. PROPOSED MODEL

3.1 Block Diagram

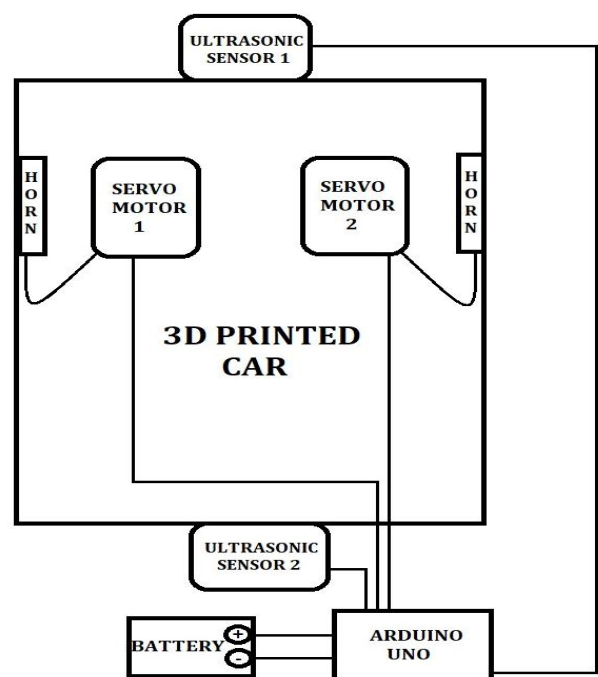

Fig-5: Block Diagram

NOTE: Horn in the image is servo horn

One ultrasonic sensor will be placed at the front of the car and another ultrasonic sensor will be placed at the rear part of the car in order to sense for any object approaching towards the car. Arduino is placed outside the car along with a 9V battery as a power supply. Two servo motors will be placed inside the car. Each servo motor will be associated with each servo horn which in turn controls the locking and unlocking of the door. These servo motors are connected to the Arduino. Two ultrasonic sensors are also connected to the Arduino, one ultrasonic sensor is placed at the front and other ultrasonic sensor is placed at back side. The front ultrasonic sensor has control of all the servo motors as well as the rear ultrasonic sensor has control of all the servo motors. The power supply is done with the help of a battery (9V battery is adequate to implement the prototype).

3.2 Working Flow

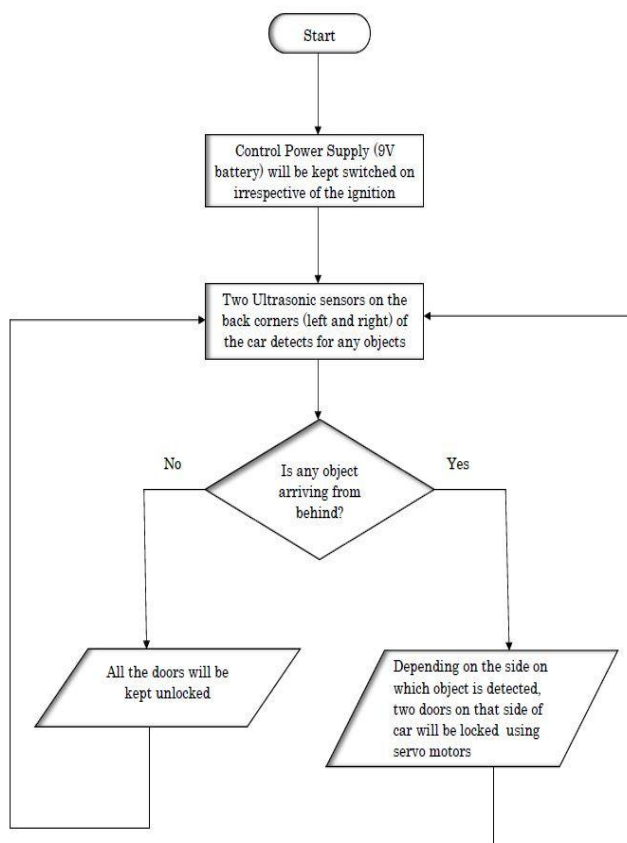

Fig-6: Working Flow

3.3 Working

The 9V battery will be always switched on for the purpose of functioning of the project even if the ignition is switched off. The ultrasonic sensor continuously detects for any objects coming from front or rear side. When there is no object found on either side of the car,

all the doors shall be kept open. Whenever any vehicle or human or object is found coming from front side of the car, the ultrasonic sensor fixed at the front side detects the object and then all the doors of the car will be locked with the help of servo motors and corresponding servo horns. Similarly, when any vehicle or human or object is found coming from rear side of the car (such that the doors get hit if opened as shown in figure 1) the ultrasonic sensor fixed at the rear side detects the object and then all the doors of the car will be locked. Whatever may be the direction of the object found, doors will be locked and will be unlocked only after 10 seconds. Because, one vehicle might be behind the other. If we immediately unlock the door after one vehicle passes and passenger inside the car tries to get down, there will be crash with the second vehicle. To avoid that, whenever the object is detected, the doors will be kept locked for 10 seconds and unlocked after 10 seconds only.

3.4 Hardware and Software Involved

Table-1: Hardware Components and Software

S.NO	COMPONENTS	NUMBER
1.	Arduino UNO	1
2.	Servo Motor (SG90)	2
3.	Ultrasonic Sensor	2
4.	3D Printed Car	1
5.	9V Battery	1
6.	Servo Horn	2
7.	Jumper Wires	As Required
8.	Printed Circuit Board	1
9.	Arduino IDE (Software)	-
10.	Fusion 360 (Software)	-

4. RESULTS

4.1 3D PRINTED CAR



Fig-7: 3D Printed Car

The 3d printed car which we used in his project is shown in the figure 7.

4.2 CIRCUIT SETUP

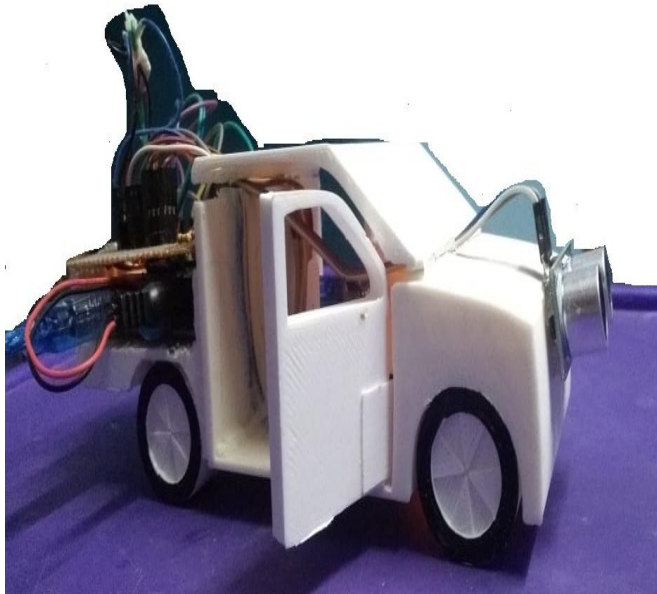

Fig-8: Circuit Setup along with Car

The circuit setup along with 3D printed car is shown in the figure 8. Since it will be difficult to interpret the door has been locked or unlocked, only two doors have been kept in the prototype.

4.3 POWER ON

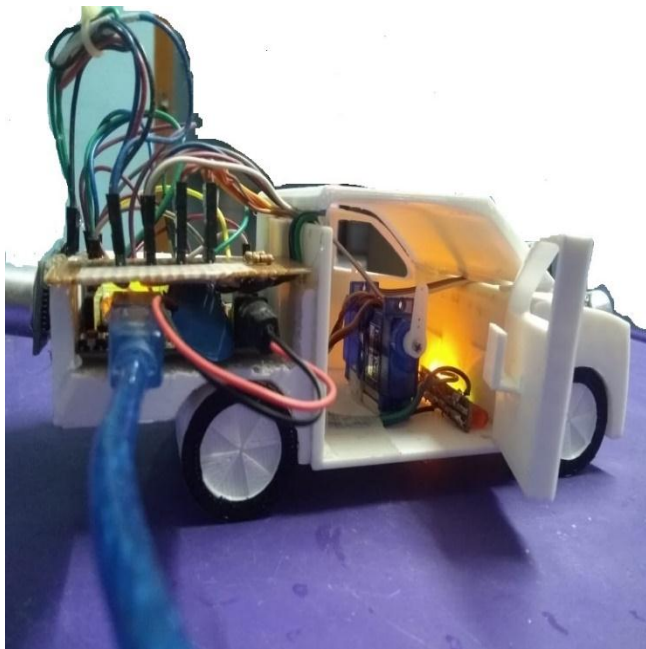

Fig-9: Power On and Door Open

The power is on and the yellow light inside the car indicates that there is no object approaching from both front and back side as shown in the figure 9.

4.4 OBJECT APPROACHING FROM FRONT SIDE

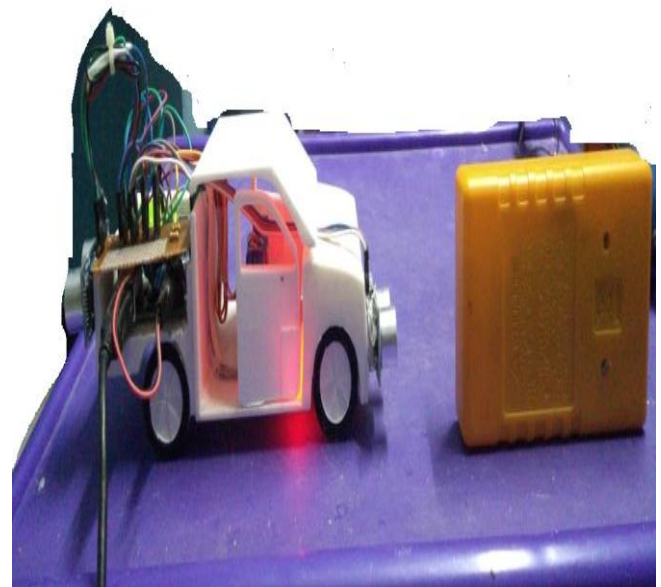

Fig-10: Object Approaching from front side

Since the object is approaching from front side, the doors inside got locked with the help of servo horns as shown in the figure 10 and the red light indicates warning to the people inside the car about vehicles approaching and door lock.

4.5 OBJECT APPROACHING FROM REAR SIDE

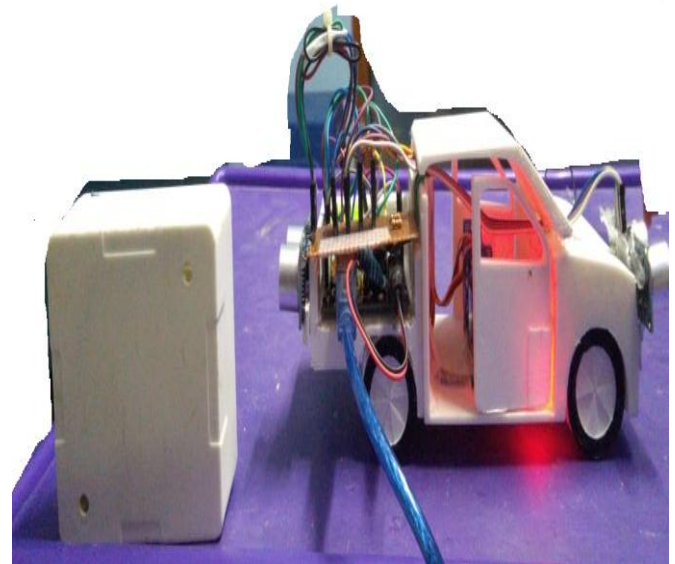

Fig-11: Object Approaching from rear side

Since the object is approaching from rear side, the doors got locked with the help of servo horns as part of functionality as shown in the figure 11 and the red light indicates warning to the people inside the car about vehicles approaching and door lock.

4.6 OBJECT APPROACHING FROM BOTH SIDES

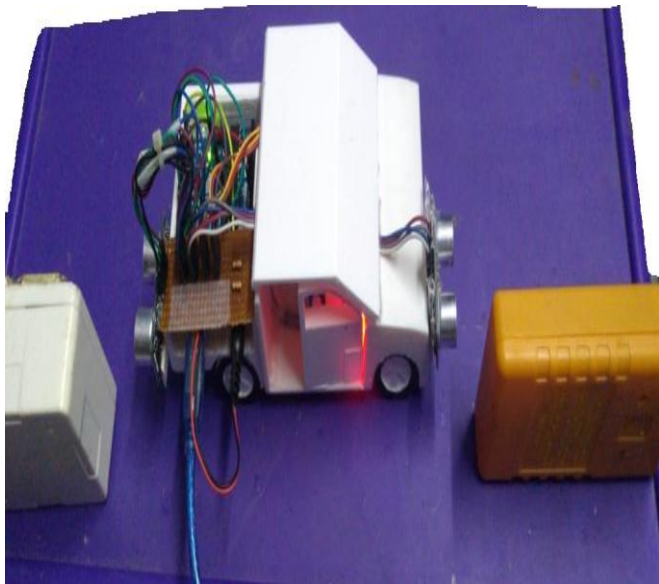

Fig-12: Object approaching from both sides

Since the objects are approaching from both the sides i.e., front and back, the doors are locked as part of functionality as shown in the figure 12 and the red light indicates warning to the people inside the car about vehicles approaching and door lock. In this way, we can control all the doors depending upon the approaching of other vehicles towards a car.

5. CONCLUSION

We conclude that the idea we chose for this project is never before taken into consideration in automobile history. This project not only has ability to protect people inside a vehicle but also people outside the vehicle. This project is not restricted to INDIA only, but can be implemented in any country worldwide because the victims who suffered due to this involuntary action belong to all the countries who use cars of all types like sedan, hatchback, SUVs and cab services. This project not only save people from injuries but also saves vehicle damage along with financial damage. The sole objective of this project is to ensure safety of human beings who use cars.

5.1 FUTURE SCOPE

Though the prototype which we have established does not integrate with the actual locking system of the car, this can be done in future with the help of car manufacturing companies. This embedded system can be enhanced using camera module associated with side mirrors, image processing so that feature becomes authentic as other built in features inside the car. This feature can be utilized in each and every vehicle which uses doors. These vehicles might be autos, trucks, buses. This feature can be equipped not only in three and four-

wheeler vehicles but also two wheelers because the same precaution needs to be taken in case of two-wheeler vehicles too. This feature has to be imparted into vehicles during manufacturing itself as the sensor part should be attached with latch of the door. It becomes a bit difficult task to impart this feature into existing cars but can be done by hook or crook.

REFERENCES

- [1] Venkatesh PL, Vivek C, "Safety Locking System of Car Door Using Sensors" International Journal of Science and Research (IJSR), Volume 5 Issue 3, March 2016
- [2] <https://www.youtube.com/watch?v=arAC83PWjsg>
- [3] <https://www.youtube.com/watch?v=d08XqqZK-XQ>
- [4] <https://www.youtube.com/watch?v=TgtrKLCDbPc>

BIOGRAPHIES



A Rajadattu,
Studying at Sreenidhi Institute of Science and Technology, Dept. of Electronics and Communication and Engineering



D R Raghavendra Rao,
Studying at Sreenidhi Institute of Science and Technology, Dept. of Electronics and Communication and Engineering



S Mahesh Kumar Reddy,
Studying at Sreenidhi Institute of Science and Technology, Dept. of Electronics and Communication and Engineering



Dr G Ganesh Kumar,
Assistant Professor at Sreenidhi
Institute of Science and
Technology, Dept. of Electronics
and Communication Engineering.