

An IOT Based Smart Fan Module

Anup Bind¹, Kiran Ashtankar², Prof. Mahesh Chahare³

^{1,2,3}Department of Electronics and Electronics & Telecommunication, Wainganga College of Engineering and Management Dongargaon, Nagpur, Maharashtra

Abstract: Now day there are various requirements of common-man. Internet of Things is going to play essential role in application such as smart home, industrial internet, healthcare and security systems, smart cities, etc. In this work, we are implementing smart digital fan module for controlling fan speed based on room temperature, and also turn on or turn off based on presence or absence of man body. And also we can access the temperature remotely through cloud. Temperature of the room can be sensed by using DHT11 temperature sensor. The sensed signal is send to microcontroller. If temperature is low then fan rotates slowly and if the temperature is high then the speed of the fan will be high. ESP8266 Wi-Fi is interfaced with microcontroller to show the current status of the project with help of mobile phone. The developed approach is benefited regarding preventing the waste of energy when it is not hot enough to use a fan and assist the disabled to switch on or off fan automatically.

Keywords- IOT, BLYNK, DHT11 sensor, PIR sensor, PWM, ESP8266 Wi-Fi.

1. INTRODUCTION

Now day everyone is looking towards smarter and automated technologies. A microcontroller is used to make a thing smart. A microcontroller called AVR.ATmega2560 Arduino is used to control and automate processes. It is a single chip that execute code. In this paper we are using pulse width modulation for controlling the speed of Brush less DC fan and also display the speed of fan and DHT11 temperature value for this we are using 16x2 LCD. To operate the Brush less DC fan required 25KHZ frequency we used pin 13 of Arduino mega and also install the PWM library to achieve that amount of frequency. To sense the temperature value from any place we are using ESP8266 Wi-Fi module which is connect to the Arduino mega. In this paper we are using three push button for setup the fan speed as your requirement. These push button play an essential role for setting the temperature value and also speed of fan.

2. LITERATURE REVIEW

Jahnavi v. Siva priya .A.G.Jaga ,Rao & keerutiburt kanchanasation have proposed controlling fan speed using Arduino Uno microcontroller which has only 32k byte flash program memory & also 2k byte EEPROM data memory & also 2k bytes SRAM data memory but Arduino

mega microcontroller which has 256k byte flash program memory & 8k byte EEPROM data memory and also 4k byte internal SRAM. In this project we are using EEPROM memory to setup the speed of fan according to the real time temperature value .using three push button with help of three push button we can change the previous data & enter the new data according to our requirement in the EEPROM of the Arduino mega .for this project Arduino mega has sufficient EEPROM memory.

METHODOLOGY

In this paper we are designing an IOT based smart fan module. To sense the room temperature we used DHT11 temperature sensor. According to the sense room temperature ATmega2560 control the speed of fan. For controlling the speed of fan apply the $F = F + tempcal$ sensor calibration where F is represent the Fahrenheit Temperature value. If F is less than tempMin then speed of fan is zero or desired fan speed is FanMin. If F is greater than the tempmax the desired fan speed is FanMax. For setup the value of Tempcal, TempMin, Tempmax, FanMin & FanMax we use man bar for this purpose we used three push button, also used PIR sensor for detecting human motion to turn ON or turn OFF the fan. Accessing data from a particular place by esp8266 Wi-Fi module. For this we are used DHT11 sensor, PIR sensor, and esp8266 Wi-Fi module.

Block Diagram of Smart Fan Module

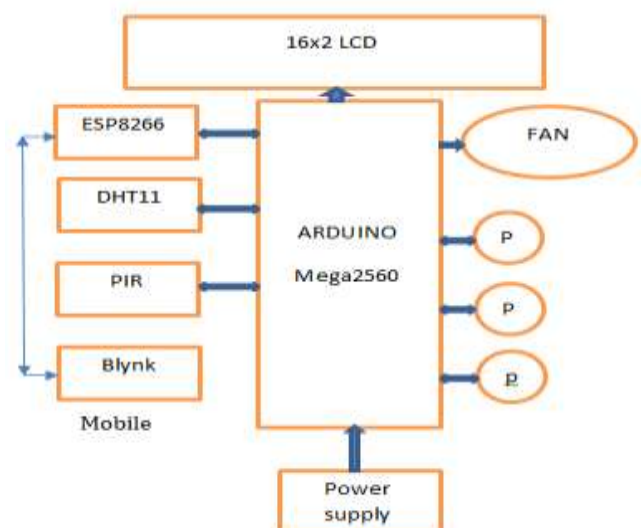

ARDUINO Mega2560:-

The Arduino Mega 2560 is a microcontroller board based on the ATmega2560 (datasheet). It has 54 digital input/output pins (of which 14 can be used as PWM outputs), 16 analog inputs, 4 UARTs (hardware serial ports), a 16 MHz crystal oscillator, a USB connection, a power jack, an ICSP header, and a reset button. It contains everything needed to support the microcontroller; simply connect it to a computer with a USB cable or power it with a AC-to-DC adapter or battery to get started. The Mega is compatible with most shields designed for the Arduino Duemilanove or Diecimila.

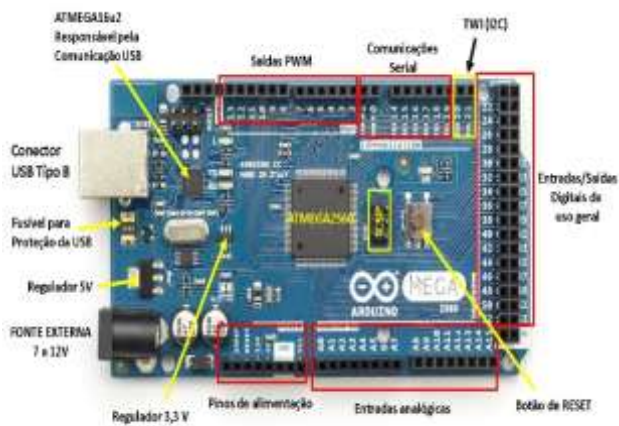

Fig.1 Arduino mega2560

ESP8266 Wi-Fi Module:-

ESP8266 Wi-Fi module is a device which is interfaced with the Arduino board gives the Wi-Fi ability which works similar to Wi-Fi shield. It works with AT command set. This module has a power on-board processing and storage capability that allows it to be integrated with the sensor and other application through its GPIOs. ESP8266 Wi-Fi module used for storing data in cloud.

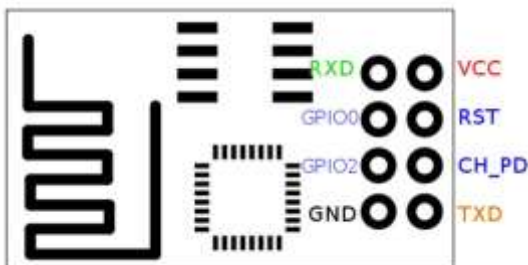

Fig.2 ESP8266 Wi-Fi Module

DHT11 (Temperature) Sensor:-

DHT11 temperature AND Humidity sensor features a liberated digital signal output with the temperature and humidity sensor. It has excellent quality, fast response. It is available at ultralow cost. DHT11 sensor containing

Data. Voltage and Ground that are used for connecting Arduino mega board.

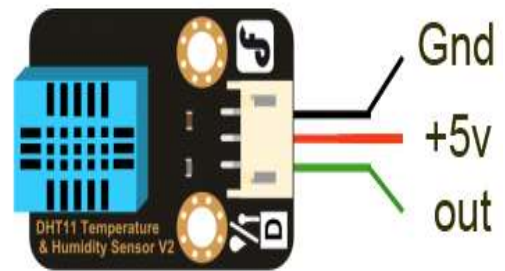

Fig.3 DHT11 (Temperature) sensor

PIR Sensor:-

A passive infrared sensor (PIR sensor) is an electronic sensor that measures infrared (IR) light radiating from objects in its field of view. They are most often used in PIR- based motion detectors. PIR sensors are commonly used in security alarms and automatic fan applications. PIR sensors are commonly called simply "PIR" or sometimes "PID", passive infrared detector". The term passive refers to the fact that PIR devices do not radiate energy for detection purposes. They work entirely by detecting infrared radiation (radiant heat) emitted by or reflected from objects.

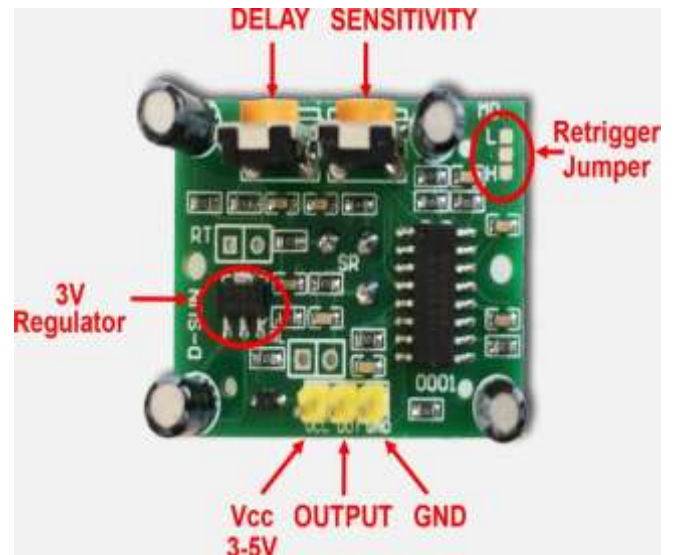

Fig.4 PIR sensor

Push Button Switch:-

Push-button are normally-open tactile switches. Push button allow us to power the circuit or make any particular connection only when we press the button. Simply, it makes the circuit connect when pressed and breaks when released. A push button is also used for triggering of the SCR by gate terminal. These are the most common button which we see in our daily life electric equipment's. Some of the application of the push

button are mentioned at end of the article. When connecting in between of supply and the circuit we should only connect the wires with both the legs of the push-button.

A push -button can also be used for the triggering purpose like of SCR. An SCR is a gate controlled switch which needs a triggering pulse. So, for this we can add a push button in the circuit to give a triggering-pulse.



BLDC Fan:-

This specification defines the intended operation of a fan that implements the Pulse Width Modulation (PWM) control signal on the 4-wire fan interface. The introduction of 4 wire PWM controlled fans is a means to reduce the overall system acoustics. The expectation is a 4 wire PWM controlled fan when properly implemented will be significantly quieter than a similar 3 wire fan. Fan operating voltage shall be within the range 12 V ±1.2 V. Peak fan current draw during start-up operation (with 13.2 V applied, with fan operating in the free stream condition) shall not exceed 2.0 A.

Fan current spike during start-up operation (with 13.2 V applied, with fan operating in the free stream condition) shall be allowed to exceed 1.0 A for a duration of no greater than 1.0 sec.

PWM Control Input Signal

The following requirements are measured at the PWM (control) pin of the fan cable connector:

PWM Frequency: Target frequency 25 kHz, acceptable operational range 21 kHz to 28 kHz

Maximum voltage for logic low:

VIL = 0.8 V

Absolute maximum current sourced: I_{max} = 5 mA (short circuit current)

Absolute maximum voltage level:

V_{Max} = 5.25 V (open circuit voltage)

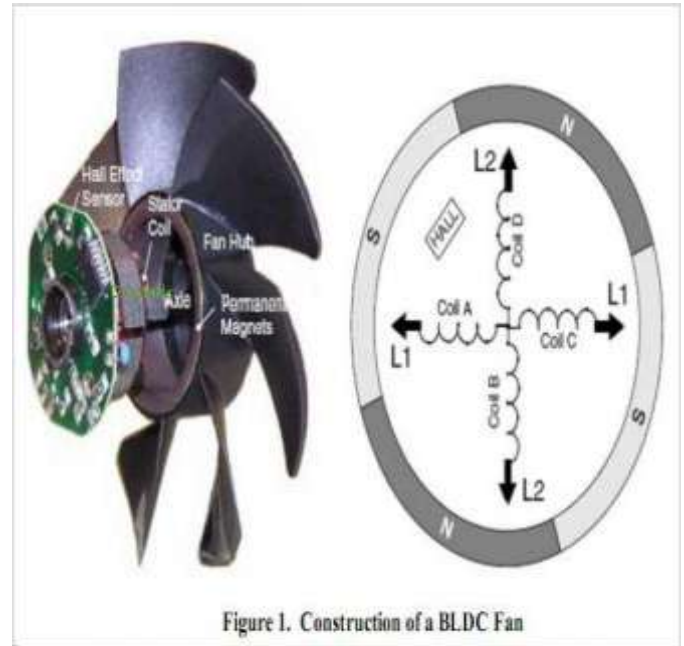

Figure 1. Construction of a BLDC Fan

Fig.5 BLDC Fan

Fan Speed Control

Maximum Fan Speed Requirements .The maximum fan speed shall be specified for the fan model by the vendor and correspond to 100% duty cycle PWM signal input.

Minimum Fan Speed Requirements

The vendor shall specify the minimum RPM and the corresponding PWM duty cycle. This specified minimum RPM shall be 30% of maximum RPM or less. The fan shall be able to start and run at this RPM. To allow a lower specified minimum RPM, it is acceptable to provide a higher PWM duty cycle to the fan motor for a short period of time for start -up conditions. This pulse should not exceed 30% maximum RPM and should last no longer than 2 seconds.

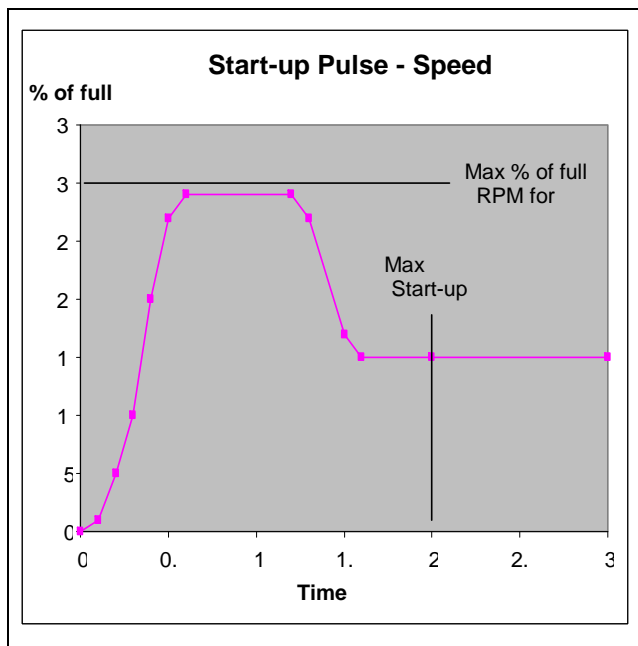

Result & conclusion:-

An efficient fan controller based on room temperature by using ARDUION mega board has been developed. Output was checked by setting the temperature at different levels with help of push button and it was found that the fan speed changes accordingly. It is very useful to the people who are disabled. There is much future scope for this work. The design circuit can be used in many practical applications, where the circuit can be connected to a device for whose temperature has to be controlled at a particular value. For e.g. a water tank with heater whose temperature can set to a desired value. In future the designed circuit can be connected to a GSM Module so that it can be used in industrial areas when a machine crosses its desired temperature. We can send a message to the control room so that damage of the machine can be avoided.

ACKNOWLEDGMENT:-

We are our thanks to the support given by management in completing our work. We express our sincere gratitude & deep sense of respect to Mr. Rahul Navakhare, HOD & Associate professor of the Electronic and Telecommunication Department. We express our sincere thanks to our work guide Mr. Mahesh Chahare Assistant professor for his support to completion of this work. We are thankful to the teaching and non-teaching staff of Electronic and telecommunication department for their direct as well as indirect help in our work.

REFERENCES

[1] Jahnvi.Y, Siva Priya.A “An IOT Appliance for Controlling the Fan Speed and Accessing the Temperature through cloud Technology using DHT11 sensor “, international journal on future Revolution in computer science & communication Engineering volume:4 issue:4.2018.

[2] Keeratiburt Kanchanasatian, “Automatic Speed Control and Turning ON/OFF for Smart Fan by Temperature and Ultrasonic sensor”,IOP Conf. Series: Materials Science and Engineering 325(2018).

[3] G. Joga Rao,“Temperature Controlled Fan Using IOT”, B. Tech Student EEE Department, volume: 4 issue: 4(2018).

[4] Vaibhav Bhatia Gavish Bhatia,“ Room Temperature based Fan Speed control system using Pulse width Modulation Technique”, international journal on future Revolution in computer science & communication Engineering volume:811-No5, November 2013.

[5] Subhankar Cottoraj,“Smart home Automation based on different sensors and Arduino as the master controller”, international journal on future Revolution in computer science & communication engineering volume: 5 issue: 10. Oct 2015.