

A New Three-Level Diode Clamped Multilevel Inverter Topology

Kishan kumar Shukla¹, Surya Prakash Mishra², Roopa Devi Sahu³, Akansha Prajapati⁴

^{1,2,3,4}(Department of Electrical Engineering), Madhav Institute of Technology and Science Gwalior

ABSTRACT - Multilevel inverter composed of an array of power semiconductor and capacitive voltage source. It generates multiple step voltage waveforms with variable frequency phase and amplitude. MLI is used for high power and power quality demanding applications. This paper shows the simulation result and implementation of three phase three level multilevel inverter (MLI).

Keywords - Multilevel inverter, Diode clamped multilevel inverter, Total harmonic distortion, Power Quality.

1. INTRODUCTION

Recently, induction motors are widely used in residence and industries because of compact size, and cheap price. However, industries are required to improve its efficiency by employing various controls and to save energy. In this paper, the concept of a 3-level diode-clamp and modulate principle are implemented to control the output waveform approaching the sine-wave as close as possible, because sine wave is less pekey in nature and less insulation is required. In recent years, industry has begun to demand higher power equipment, which now reaches the megawatt level. Controlled AC drives in the megawatt range are usually connected to the medium voltage network.

The mli has been introduced in 1975 as an alternative in high power and medium voltage situations. Multilevel inverters have become attractive recently particularly because of the increased power ratings, improved harmonic performance.

To be called a multilevel converter each face of converter has to generate at least three different voltage level. generally different voltage levels are equidistant from each

2. MULTILEVEL INVERTER TOPOLOGY-

The general structure of the multilevel inverter is to synthesize a sinusoidal voltage from several levels of voltages typically obtained from capacitor voltage sources. Multilevel inverters are being considered for an increasing number of applications due to their high power capability associated with lower output harmonics and lower commutation losses.

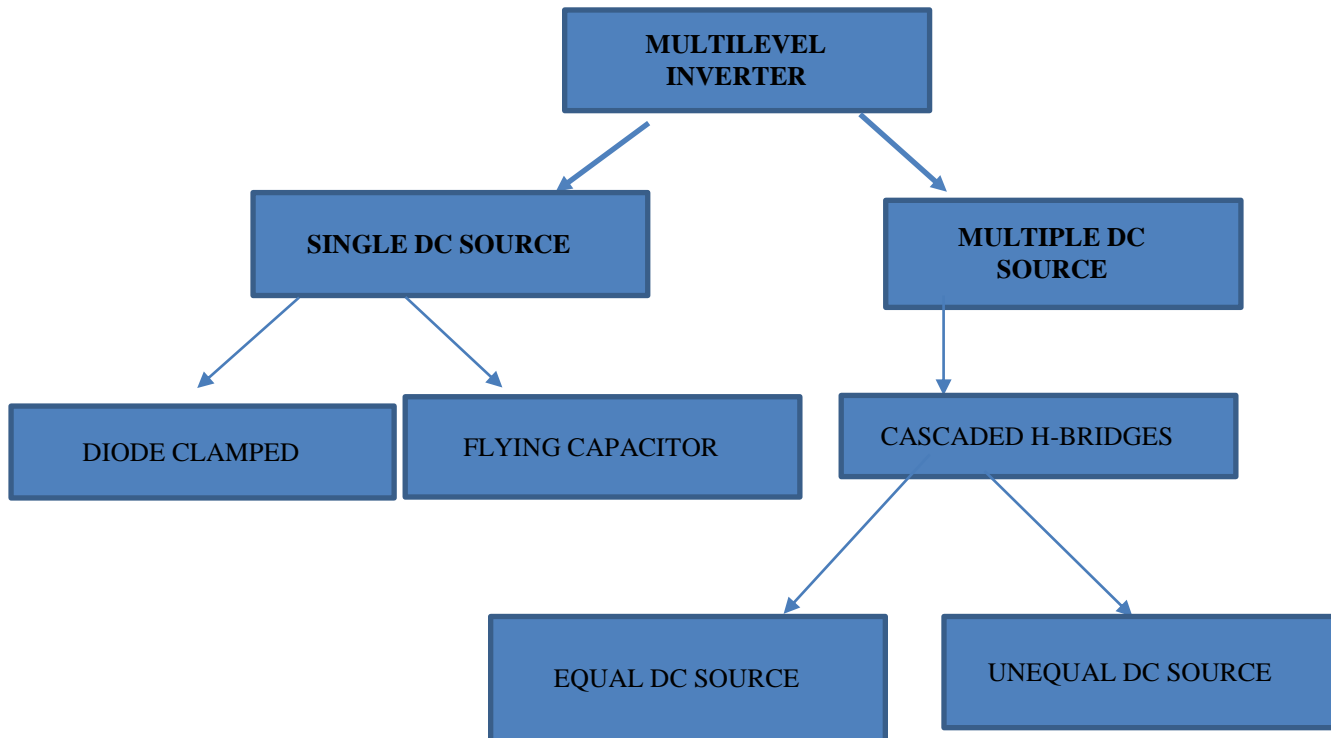

The main multilevel topologies are classified into three categories-

- i. Diode clamped inverters
- ii. Flying capacitor inverters
- iii. Cascaded inverters.

In a three phase inverter system, the number of main switches of each topology is equal.

3. DIODE-CLAMP MULTILEVEL INVERTER - The most commonly used multilevel topology is the diode clamped inverter also known as neutral fed inverter, in which the diode is used as the clamping device to clamp the dc bus voltage so as to achieve steps in the output voltage. Thus, diode is used to limit the voltage stress. The voltage over each capacitor and each switch is V_{dc} . By increasing the number of voltage levels the quality of the output voltage is improved and the voltage waveform becomes closer to sinusoidal waveform.

In this topology there are two pairs of switches and two diode are consists in a three-level diode clamped inverter. All switch pairs work in complimentary mode and the diodes used to provide access to mid-point voltage. The DC bus voltage is divided into three voltage levels with the help of two series connections of DC capacitors, C1 and C2. With the help of the clamping diodes Dc1 and Dc2 the voltage stress across each switching device is partial to V_{dc} . It is supposed that the total dc link voltage is V_{dc} and mid point is synchronized at half of the dc link voltage, the voltage across each capacitor is $V_{dc}/2$ ($V_{c1}=V_{c2}=V_{dc}/2$). In a three level diode clamped inverter, there are three different feasible switching states. At any time a set of two switches is on for a three-level inverter. Fig.1. shows the three level diode clamped MLI.

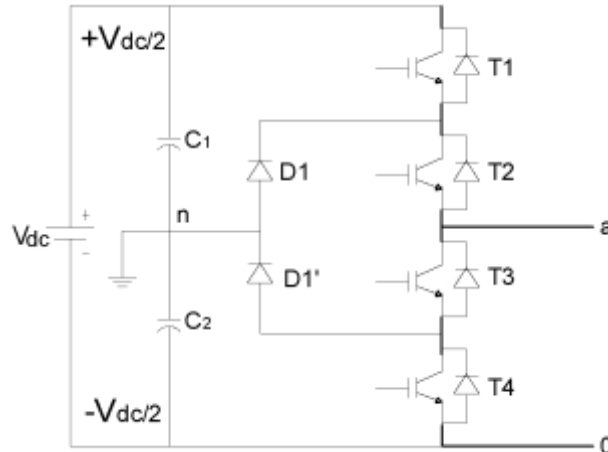

Figure1. Diode clamped multilevel inverter circuit topology for 3-level inverter.

Table.1 shows the switching states in one part of the three-level DIODE CLAMPED INVERTER. In a three level diode clamped inverter, there are three different feasible switching states which apply the stair case voltage on output voltage relating to DC link capacitor voltage rate. At any time a set of two switches is on for a three-level inverter.

Switch State	State	Pole Voltage
T1=ON,T 2=ON T3=OFF,T 4=OFF	S=+ve	Vao=Vdc/2
T1=OFF,T 2=ON T3=ON,T 4=ON	S=0	Vao=0
T1=OFF,T2=OFF T3=ON,T 4=ON	S=-ve	Vao=-Vdc/2

Multilevel inverters have become an effective and practical solution for increasing power and reducing harmonics of AC load.

4. Cascaded H-Bridges - One more alternative for a multilevel inverter is the cascaded multilevel inverter or series H-bridge inverter.formed by the series connection of two or more single phase h bridge inverter .Cascaded multilevel inverter was not fully realized until two researchers, Lai and Peng. They patented it and accessed its various advantages in 1997.

Since then, the CMI has been used in a wide range of applications.

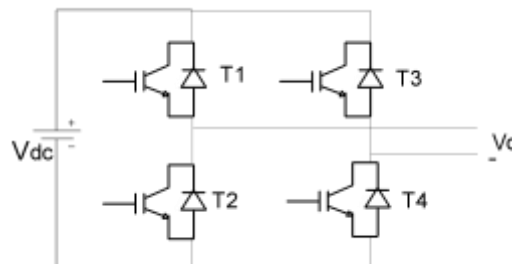

Figure2 Cascaded H-bridge multilevel inverter circuit topology for 3- level inverter.

5. Flying Capacitor Multilevel Inverter - The capacitor clamped inverter alternatively known as flying capacitor mli. The structure of this inverter is similar to that of the diode-clamped inverter.complex capacitor voltage balancing. The flying capacitor involves series connection of capacitor clamped switching cells. One feature is that added clamping diodes are not needed except that instead of using clamping diodes the inverter uses capacitors in their place. Figure 3 shows the three-level flying capacitor inverter. Furthermore, the flying capacitor inverter has switching redundancy within the phase, which can be used to balance the flying capacitors so that only one dc source is needed.large number of capacitor required in pre charged condition

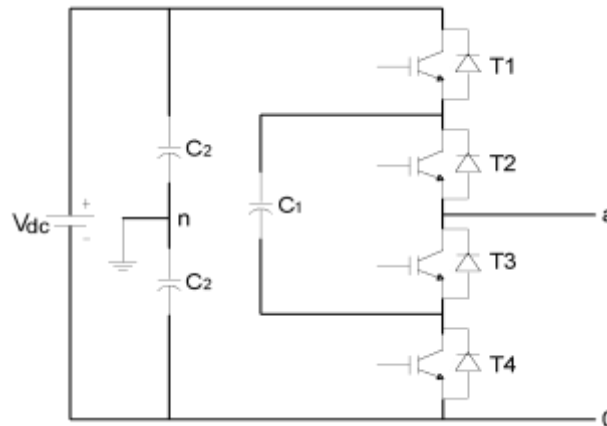

Figure3 Flying Capacitor multilevel inverter circuit topology for 3- level inverter

6. Modulation Techniques - Multilevel converters are mainly controlled with sinusoidal PWM extended to multiple carrier arrangements of two types: Level Shifted pulse width modulation, which includes Phase Disposition, Phase Opposition Disposition and Alternative Phase Opposition Disposition or they can be Phase Shifted. In propose topology POD is used. Figure 4 shows the multilevel converter modulation methods.

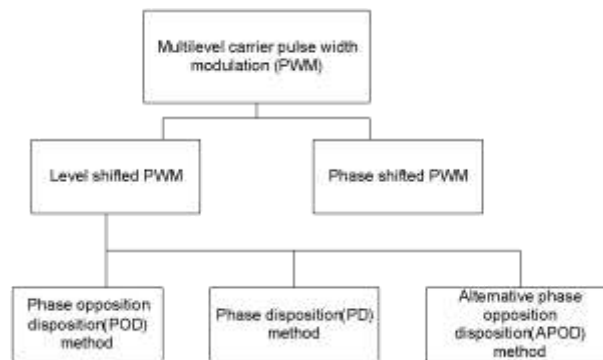

Figure 4 Block Diagram of Multicarrier Pulse Width Modulation

7. Level Shifted PWM (LSPWM) :- This modulation method is especially useful for NPC converters, since each carrier can be easily associated to two power switches of the converter. LSPWM leads to less distorted line voltages since all the carriers are in phase compared to PSPWM.

- a) *Phase disposition (PD) technique*:- With the wide application in multi -level inverters, this technique has all carriers in phase. It requires four carrier waveforms. The zero reference is placed in the middle of the carrier sets.
- b) *Alternative phase opposition disposition (APOD) technique*:- This technique requires four carrier waveforms, which are phase-displaced by 180° alternate.
- c) *Phase opposition disposition (POD) technique*:- This technique requires four carrier waveforms that are all in phase above or below the zero reference value. However, they are phase shifted by 180° between the carrier waveforms above and below zero.

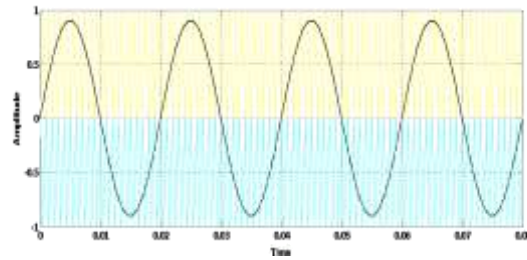

Figure 5 LS-PWM carrier arrangements: (b) POD

8. SIMULATION RESULTS:-

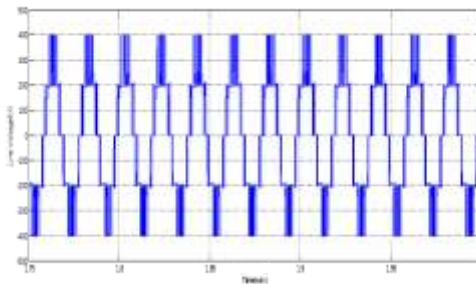

Figure 6 line voltage waveform VLL for 3-level of DCMLI using PODPWM technique.

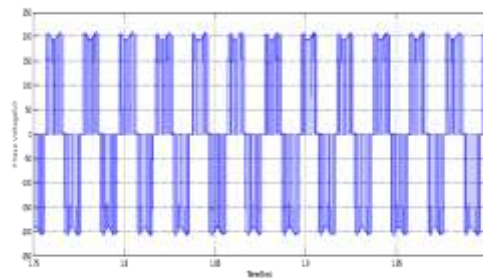

Figure 7 Output Phase Voltage Waveform Vph For 3-Level of DCMLI using PODPWM technique.

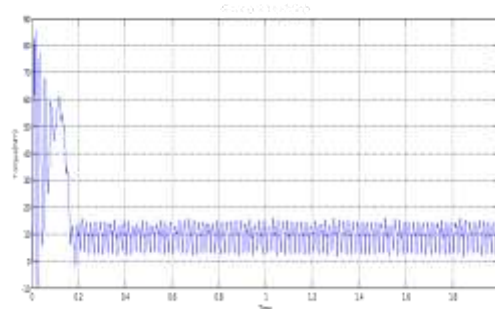

Figure 8 Rotor current characteristics of DCMLI fed IM drive.

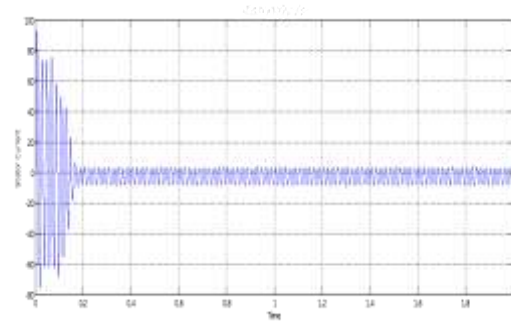

Figure 9 Stator current characteristics of DCMLI fed IM drive.

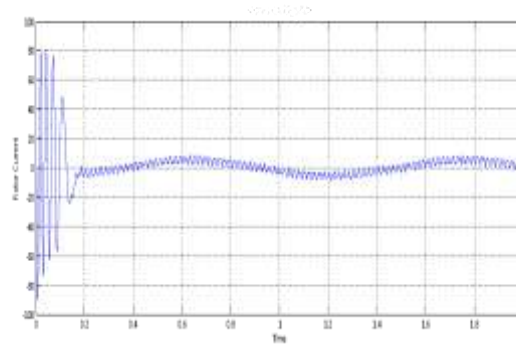

Figure 10 Torque characteristics of DCMLI fed IM drive.

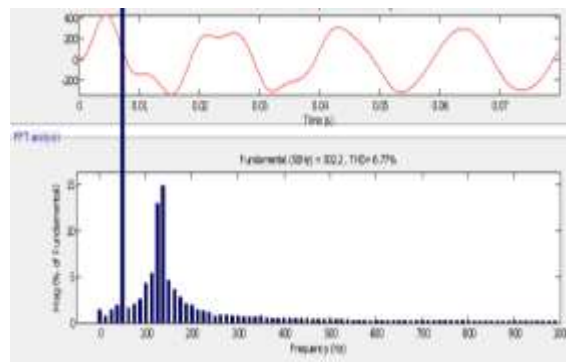

Figure 11 FFT plot for PODPWM strategy in 3-level for IM load.

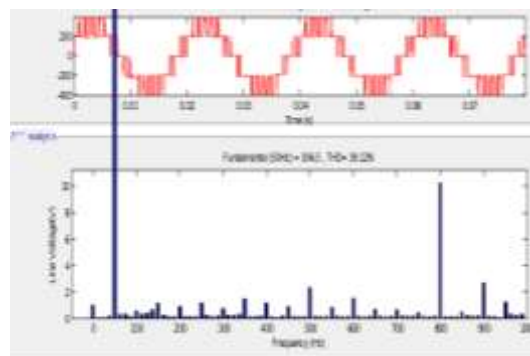

Figure 12 FFT plot for output phase voltage of PODPWM technique in 3-level DCMLL for IM load.

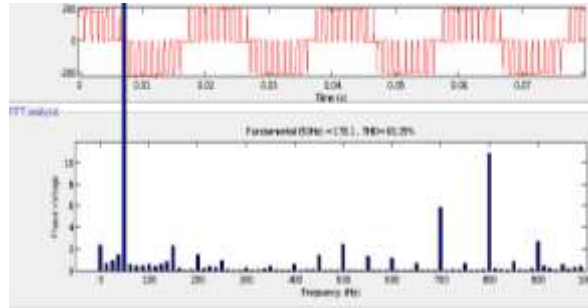

Figure 13 FFT plot for output phase voltage of PODPWM technique in 3-level DCMLI IM load.

8. Conclusions:-

The working of a mli has been explained in details. It can be observed the MLI offered low harmonics and high efficiency MLI is suitable for high voltage and high power application

The output quantities like phase voltage and line voltage, THD spectrum for phase voltage and line voltage and torque, rotor current, stator current characteristics of induction motor are obtained.

The three level inverter fed induction motor system has been successfully simulated

9. ACKNOWLEDGMENT:-

The authors sincerely acknowledge the Director, MITS Gwalior, India to carry out this work.

10. Reference:-

1. Rodriguez, J., Jih-Sheng Lai, Fang ZhengPeng, "Multilevel inverters: a survey of topologies, controls, and applications," Industrial Electronics, IEEE Transactions on, vol.49, no.4, pp. 724- 738, Aug 2002.
2. Mr. G. Pandian and Dr. S. Rama Reddy, "Implementation of Multilevel Inverter-Fed Induction Motor Drive" Journal of industrial technology ,Vol.24 , no.1, April 2008 through June 2008.
3. Dhaval Patel, Himanshu N. Chaudhari, Hina Chandwani &Anand Damle, "Analysis & Simulation of Asymmetrical Type Multilevel Inverter Using Optimization Angle Control Technique" Dept of Electrical Engineering, The M.S. University of baroda.
4. J. Rodriguez, S. Bernet, B. Wu, J.O. Pontt, S. Kouro, Multilevel voltage-source converter for industrial medium-voltage drives, IEEE Trans. Ind. Electron. 54 (6) (2007) 2930–2945.
5. Diode clamped multilevel inverter- : <http://engineering.electrical-equipment.org/electricaldistribution/diode-clamped-multilevel-inverters.html>.
6. Nptelhrd : Mod-13 Lec-38 PWM for three-level neutral-point-clamped inverter – I.