

# IoT BASED SMART MASK WITH AIR PURIFICATION AND BODY VITALS MONITORING SYSTEM

PAVITHRA M<sup>1</sup>, PREETHA S S<sup>2</sup>, PUGAZHI D<sup>3</sup>, SELVARAJ M<sup>4</sup>

<sup>1,2,3</sup>UG student, SRM Valliammai Engineering College, Chennai, India.

<sup>4</sup>Assistant Professor, Department of Electronics and Communication, SRM Valliammai Engineering College, Chennai, India.

\*\*\*

**Abstract** - On the growing population, air pollution is one of the world single biggest environmental risk factors. It is one of the leading causes of non-communicable diseases, such as stroke, cancer, and heart disease. In this paper, we are presenting an innovative IoT based portable unit for an individual while staying outside home. This device provides pure air for breathing, relief for sun stroke and remote monitoring. Initially, the unit senses air pollution level and provides pollution free air to breath in a highly polluted area. It also senses environmental temperature and humidity. When the air discomfort level which is an index derived from the temperature and the level of other gases except oxygen, goes high it generates alarm. Heartbeat can also be sensed by a heartbeat sensor. Then observed data is transmitted through a Wi-Fi module to a useful destination where automatic monitoring and necessary actions are initiated. The proposed unit will be highly useful in coming days and give relief to people to a great extent.

There exists a constant air quality index in the range between 300 and 400 that is considered to be very poor air condition for breathing. When people inhale this kind of air and lives in such a situation, their occurs lot of health issues. Hence, using this kind of portable air purifiers may help them overcome such breathing issues.

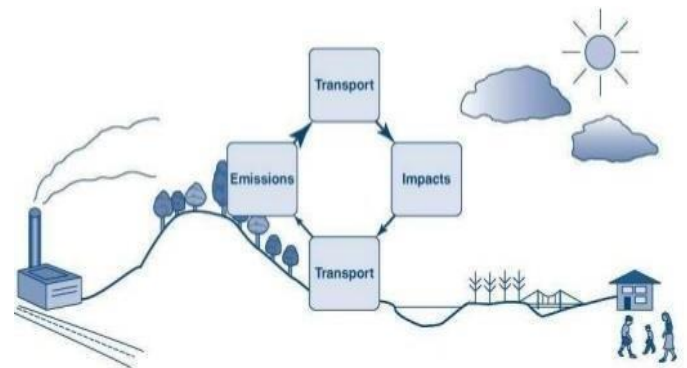

**Keywords:** Remote monitoring; sensors; Wi-Fi module; non-communicable diseases; discomfort index.

## 1. INTRODUCTION

Air pollution is the major existing and increasing risk factor day by day. The polluted air refers to the condition in which the occurrence of toxic substances in the atmosphere such as ammonia, carbon monoxide, sulphur dioxide, nitrous oxide, methane and chlorofluorocarbons. These causes allergic to human health leading to pollution related diseases, respiratory infections, heart diseases, COPD, stroke and lung cancer. Pollutants may be indoor or outdoor. The speaking about the indoor pollutants, formaldehyde that is emitted from building materials such as carpentering and plywood. Similarly, paints and solvents also emit some volatile organic compounds. Same as that the outdoor pollutants are many, as we all know pollutants emitted from vehicles, construction work, industry chemicals, etc. Hence, considering the difficulty in breathing pattern for a general person, we are about to design a smart mask. The smart mask purifies the impure air around the person wearing it. The people feel comfortable in breathing and this widely reduces the stroke and other breathing issues. At recent times, the air pollution in New Delhi is under severe conditions.



## 2. METHODOLOGY

The proposed system has sensors such as temperature, heartbeat, CO<sub>2</sub> and respiratory sensor to monitor the person. These four sensors are connected to the analog pins of the Arduino UNO. The Arduino board is programmed with Arduino IDE, to enable the functioning of all the 4 sensor. In addition to this, an air tamer is connected to the respiratory sensor to remove the impure particles in the air. The main work of the tamer is to provide an efficient output for the person to reduce the discomfort in breathing.

When the pollution level in the atmosphere exceeds a certain level, the tamer is turned on for purification. On the other end of the Arduino board that is, at the receiver side a Wi-Fi module called ESP8266 has been connected. It is a low cost Wi-Fi microchip with a full TCP/IP stack and microcontroller capability. The memory it can store is 32kb instruction and 80kb user data. It uses the self-contained SOC integrated with an TCP/IP protocol stack which can give any microcontroller access to the Wi-Fi network. The able to do either facilitate application or offloading all Wi-Fi organizing capacities from another application processor.

The real time data obtained from the ESP8266 Wi-Fi module is updated to the IoT gateway. Thus, it helps in periodic monitoring of the person's body vitals. The IoT gateway is a device to device communication or device to cloud communication. Hence, from the data we receive in the IoT gateway is used for analysis purposes. We can also self-monitor our body parameters by connecting a LCD to the Arduino. It displays corresponding the sensor values we needed. The energy of the battery withstand up to 24+ hours and produce efficiency up to 95%.

The Fig.1. shows the block diagram of the proposed system.

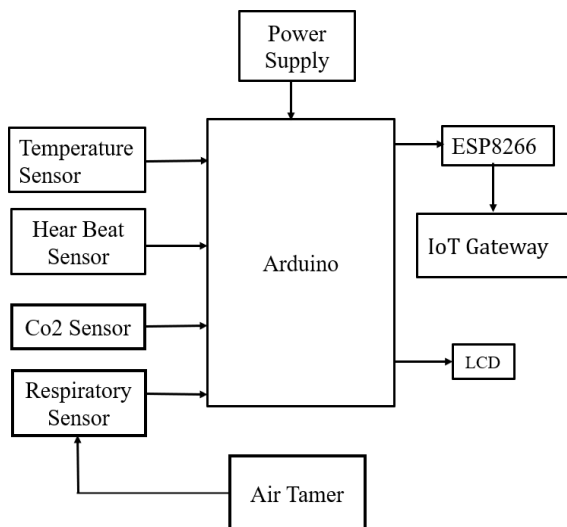

Fig.1. Block diagram of the hardware

### 3. DIFFERENT SENSORS AND COMPONENTS

Fig 2 to 10 are pictures taken as reference fromgoogle.

#### 3.1 TEMPERATURE SENSOR

In this paper, we use a basic low cost temperature sensor called LM35 that senses the body temperature. This arrangement is exactness incorporated a circuit temperature gadgets with yield voltage directly relative to a centigrade temperature. The LM35 device is rated to operate over a -55 degree Celsius to 150 degree Celsius temperature range. Fig.2. shows the LM35 sensor.

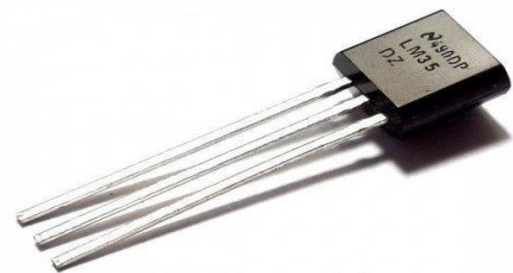

Fig.2. Temperature sensor LM35

#### 3.2 CO2 SENSOR

The Fig.3. shows the MQ135 co2 gas sensor that is used to sense the atmospheric co2 level. The most well-known standards of co2 sensors are infrared gas sensors (NDIR) and substance gas sensors. The average threshold level of co2 varies between 250 and 400 ppm. Hence, in this paper, according to the co2 level, the air tamer can be switched on. After switching the air tamer on, the co2 value reduces drastically and this can be viewed in the output.



Fig.3. Co2 gas sensor MQ135

### 3.3 HEART BEAT SENSOR

Heartbeat Sensor is an electronic gadget that is utilized to gauge the pulse i.e., speed of the heartbeat. The rule behind the working of the Heartbeat Sensor is Photoplethysmography. As per this guideline, the adjustments in the volume of blood in an organ is estimated by the adjustments in the force of the light going through that organ. Normally, the wellspring of light instantly sensor would be an IR LED, and the locator would be any Photo Detector like a Photo Diode, a LDR (Light Dependent Resistor) or a Photo Transistor. Fig.4. shows the heartbeat sensor.

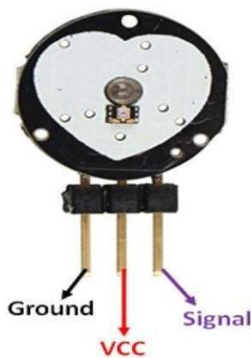

Fig.4.Heartbeat sensor

### 3.4 RESPIRATORY SENSOR

Respiratory sensor estimates the moment stream rate around the respiratory parcel while breathing in, and breathing out. By utilizing this module we can screen the respiratory example. The sensor module is with the acoustic sensor to screen the ordinary and unusual lung sounds. By utilizing the sensor the breathing issues like wheezing asthma can be distinguished. The movement of sensor is to screen the lung sounds to distinguish the breathing issues and to screen the breathing example continually. It is set inside the nasal veil. The Fig.5.shows the respiratory sensor.

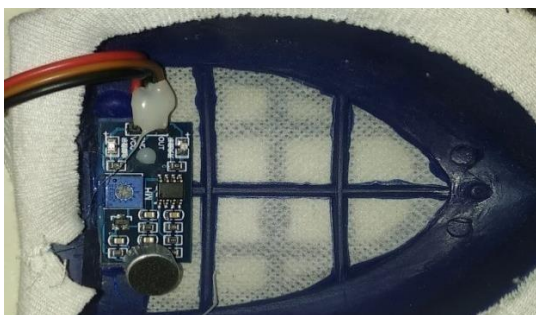

Fig.5.Respiratory sensor inside nasal mask

### 3.5 ESP8266 MODULE

The Fig.6. shows the ESP8266 Wi-Fi module. The ESP8266 Wi-Fi module with incorporated TCP/IP convention stack that can give access with any microcontroller to Wi-Fi organization. In this unit ESP8266 is utilized to communicate the got sensor information i.e., body indispensable boundaries of an individual having distress in breathing too. Here we utilize a cloud to store and show the information. By utilizing area of interest we can interface with the Wi-Fi module and update our information to the cloud. Thus, one can screen their ailment from a distant spot. It is a lot of helpful to screen people working in mechanical territories to get alleviation from breathing inconvenience.



Fig.6.ESP8266 module

### 3.6 LCD MODULE

The LCD screen is an electronic showcase module and has a wide scope of utilizations. A 16x2 LCD show is fundamental module and is ordinarily utilized in different gadgets and circuits. A 16x2 LCD implies it can show 16 characters for every line and there are 2 such lines. In this unit, we are utilizing a 16x2 LCD module which shows the body indispensable boundaries like heartbeat, temperature, breathing and co2 level in the environment. This is chiefly for individual references. The Fig.7.shows the LCD show module.



Fig.7.LCD module

#### 4. AIR TAMER

Fig.8. shows the Air Tamer, battery- powered individual or travel air purifier. Air tamer discharges negative particles from the little dark brush that you see at the highest point of the gadget. It discharges around 2 great many negative particles and push nuclear estimated contamination like infections, dust, smoke, forms and residue away from breathing zone. The Air Tamer electrostatic cleansing transmits a 3-foot circle of more secure air toward any path and making circle of assurance against destructive contamination. It has additionally a split away connector for additional wellbeing and a conductive cord which is flexible. We can essentially wear it around our neck and have a circle of breathable clear. Its energy proficient innovation gives 150+ long stretches of run time on one charge. In our proposed unit when contamination level is more prominent than limit, this air purifier is consequently turned on and the individual can breathe in natural air in general.



Fig.8. Air Tamer

#### 5. ARDUINO UNO

The Arduino UNO is an open-source microcontroller board which supports the Microchip ATmega328P microcontroller. The board is provided with sets of digital and analog input/output (I/O) pins that interfaced to various expansion boards (shields) and other circuits. The board containing 14 advanced information, and yield pins (six a fit for PWM yield), 6 a simple I/O pins, and programmable with the Arduino IDE (Integrated Development Environment), through the sort B USB link. It can be powered by the USB cable or by 9-volt battery. The following fig. 9. shows the Arduino board.

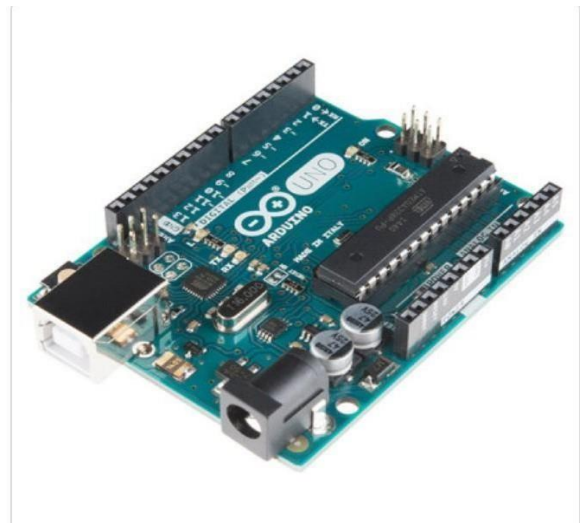

Fig.9. Arduino UNO

#### 6. NASAL MASK

The nasal cover is a sort of breathing device that fundamentally center around conveying unadulterated air. Here it contains an air pipe that sends refined air straightforwardly to breathe in. The air pipe is associated with the air tamer, so the individual gets outside air to take in. The respiratory sensor can be installed inside the nasal cover in order to get the breathing rate. The Fig.10. shows the model of nasal veil.



Fig.10. Nasal mask

### 7. FLOW CHART

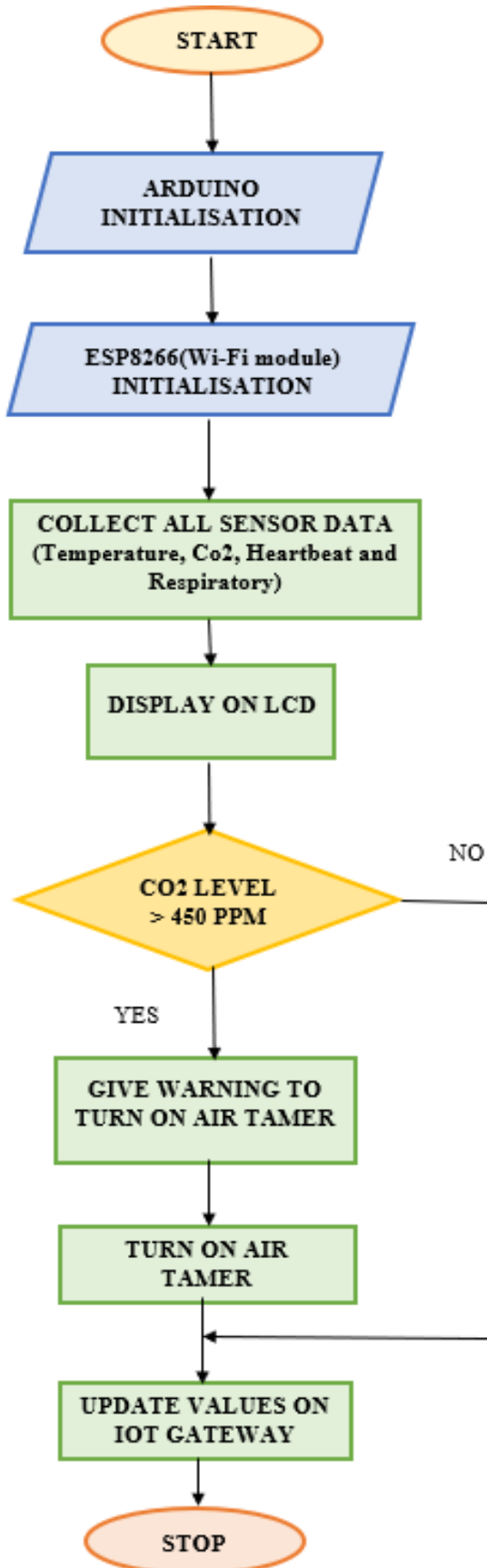

Fig.11. Flow chart

### 8. RESULTS GRAPHICAL REPRESENTATION

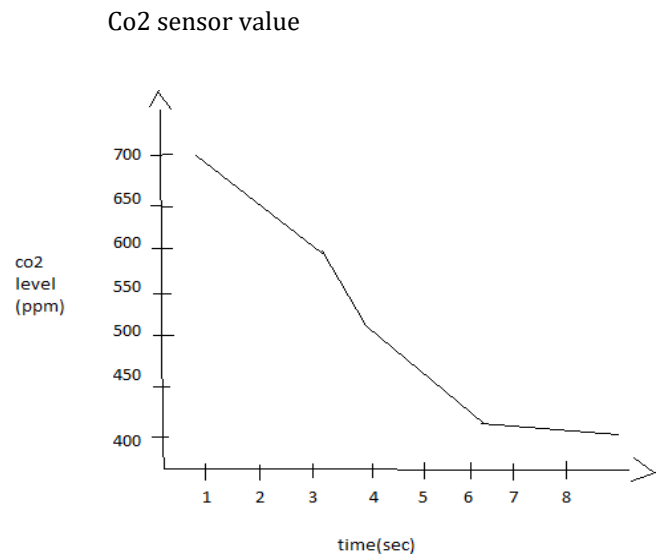

Fig.12.graph for co2 sensor value

In the above diagram, it shows the diminishing degree of co2 in the climate. At the point when the air tamer gets ON the emanation of contrary particles diffuses the abundance measure of co2 and makes the air purged and right breathing air for the individual to breathe in. The qualities can be seen at the yield in cloud or individual checking LCD shown. In Table.1. the reference values of the 4 sensors are taken from google to achieve the target range of our unit is mentioned

PARAMETERS	RANGE
TEMPERATURE SENSOR	37.8 C
RESPIRATORY SENSOR	12 to 20 breaths per minute
HEART BEAT SENSOR	60-100 BPM
CO2 SENSOR	250 to 400ppm

Table.1. Reference values of 4 sensors

### 9. CONCLUSION

The air contamination causes numerous sicknesses like asthma, stroke, cardiovascular harm, respiratory issues and so on, In this paper, we have planned a unit for advancement of humankind. We are giving a contamination free air to an individual and continually checking the body vitals of a person. The framework is carried out utilizing IoT innovation and the unit will work in a zone have a Wi-Fi or versatile organization availability.

## 10. ACKNOWLEDGEMENT

The authors gratefully acknowledge the management of SRM Valliammai Engineering College for giving the opportunity and platform for conducting this innovative project work.

## 11. REFERENCES

- [1] Z.Gai and J.Zhang, "Automatic air purification and adjusting device," 2011 International Conference on Electronics, Communications and Control (ICECC), Ningbo, 2011, pp. 1905-1908, doi:10.1109/ICECC.2011.606794
- [2] Cynthia J., Saroja M.N., P. Sultana and J.Senthil, "IoT -Based Real Time Air Pollution monitoring System", International Journal of Grid and High Performance Computing, vol. 11, no. 4, pp. 28-41, 2019. Available: 10.4018/ijghpc.2019100103. "ESP8266 WiFi Module | Sensors & Modules", Electronicwings.com, 2020.
- [3] Jenifer and D. Aravindhar, "Iot Based Air Pollution Monitoring System Using Esp8266- 12 With Google Firebase", Journal of Physics: Conference Series, vol. 1362, p. 012072, 2019. Available: 10.1088/1742-6596/1362/1/012072.
- [4] S.S.Chandrasekaran, S.Muthukumar and S.Rajendran, "Automated Control System for Air Pollution Detection in Vehicles," 2013 4th International Conference on Intelligent Systems, Modelling and Simulation, Bangkok, 2013, pp. 49-51, doi: 10.1109/ISMS.2013.94.
- [5] R. Kiruthika and A. Umamakeswari, "Low cost pollution control and air quality monitoring system using Raspberry Pi for Internet of Things," 2017 International Conference on Energy, Communication, Data Analytics and Soft Computing (ICECDS), Chennai, 2017, pp. 2319- 2326, doi:10.1109/ICECDS.2017.8389867
- [6] S. Abraham, X. Li, A cost-effective wireless sensor network system for indoor air quality monitoring applications, *Procedia Comput. Sci.* 34 (0) (2014) 165-171.
- [7] "ESP8266 Wi-Fi Module Sensors & Modules", Electronicwings.com, 2020. [Online]. Available: <https://www.electronicwings.com/sensors-modules/esp8266-wifi-module>. [Accessed:11-Jul-2020].
- [8] Soumi Karmakar, Fourth Year Student, Tapan Kumar Rana Professor, ECE Dept., IEM. Kolkata, India "IOT Based Air Discomfort Reliever" 978-1-7281-9615-2/20/\$31.00 ©2020.