

# Autonomous Vacuum Cleaning robot using Sonar Navigation and SLAM

Parth Vibhandik<sup>1</sup>, Zaid Khan<sup>2</sup>

<sup>1</sup>Student, Dept. of Electronics Engineering, Atharva college of Engineering, Maharashtra, India

<sup>2</sup>Student, Dept. of Electronics Engineering, Atharva college of Engineering, Maharashtra, India

\*\*\*

**Abstract** - This paper presents a low-cost indoor robotic vacuum cleaner which makes use of infrared, ultrasonic sensors along with path planning to simultaneously map and navigate to a specific room and obstacles lying around. The algorithm uses a linear mapping technique which maps the border of the room first rather than conventional radial mapping rotating LIDAR scanners which map unnecessary details. The robot tends to use much less power and computational resources thereby reducing the time consumed for operation.

**Key Words:** Border Mapping, RVC, PID, IMU, Room Navigation

## 1. INTRODUCTION

Robots are used as a substitute for humans in performing repetitive hazardous and quick execution task. One such problem is cleaning our house which is the environment we spend most part of our daily life in. Cleaning is something which needs to be done daily and doesn't add any value to human life. Also, according to the size of the house it may become tedious.

Although there are many Autonomous Vacuum Cleaning Robot (AVCR) in the market, their methods to cover the whole room is random with directly relates to the more consumption of power and in turn taking a lot of our time. This paper presents how our model helps in overcoming the disadvantageous short comings of existing AVCRs. AVCR is an independent mobile robot designed to clean the environment with path planning and room mapping reducing battery consumption and time taken considerably. Here our research would be focused on autonomous vacuum cleaning robot. A deep analysis was conducted on the issues currently faced by cleaning robots, with an intention to overcome and develop its core functionalities to corroborate a different approach with results.

Various algorithms and sensors were used till date in RVCs like LIDARS, Imaging, Neural networks but most of these technologies are very pricey and need high computation power. Also, high amount of redundant data gets processed hence wasting time and resources. The Aim was to extract maximum data from simple distance sensors and process in a specialized ways so as the robot can navigate and map the room as effectively as Radial rotating sensors (LIDARs). The basics of mobile robotics include of the major factors Data acquisition, Navigation, Mapping. Data Acquisition

involves collecting environmental information with the help of sensor technologies.

Navigation consists of planning algorithms and information theory based on the all-scenarios robot might be subjected to. Mapping requires to plot the extraction of sensory information and knowing the trace of movement using IOT technologies along with Network communication protocols. During the process of prototyping, we discovered the importance of closed loop system or feedback is so necessary to optimize performance of also all the systems present in the world today. The robot needs to know where it is in every moment and needs to take actions accordingly. It's termed as SLAM Simultaneous Localization and Mapping.

## 2. LITERATURE SURVEY

Conventional robotic vacuum cleaners (RVCs) with ultrasonic or infrared (IR) sensors have trouble detecting barriers when sweeping the floor in complex conditions, such as thin-legged tables or chairs. Different methods were implemented for navigation using (e.g.: Sonar, GPS, IMU, Laser) [1]. Computer Vision is the most extensively used go to sensor for navigation [1]. There are variations in organized and unorganized ways of navigating in the environment [1]. The most popular method used by various AVCR is random movements.

A camera provides more detail which demands for a high-end processing capability [2]. It's too expensive and big for service robots that are being commercialized as robots of high performance and low-cost parameters [2]. In a sensor accuracy is standouts to be the most promising characteristics taken into account for environment recognition [3]. Sensor Fusion can be a capable technique to for effective implementation [3]. Ultrasonic sensor along with the benefits brings in a drawback of irregularity in the measurement [3]. Due to the recent advancements in the image processing industry Vision sensors are being implemented extensively [3].

Ultrasonic sensor is used to take measure of distance in the room till the highest range measured by ultrasonic sensor in all the direction. A camera will then be used to measure angle between each of those sensors. Forming a right-angled triangle and mapping the boundaries with proper measurement and orientation. This is done using Pythagoras theorem [3]. A logistic robot by Implementing SLAM created a remarkable advancement [4]. The progress being, the mapping speed is proportional to the acceleration of the robot [4].

After the implementing of a feedback system using encoder, GPS and internal navigation equation [4]. Selecting the type of differential drive for the application is crucial as it lays down the foundation all the mobility related aspects.

2WD (Wheel Differential Drive) will consist of 2 motors and 2 wheels but it will require an additional balancing system [5]. 3WD will consist of 2 motors 2 wheels 1 castor ball [5]. 4WD will consist of 4 motors 4 wheels [5].

Using 3 Ultrasonic sensors on the top-left top center and top right of the robot, with the help of fuzzy logic table, boundaries are determined and different combinational set of outputs generated and by analyzing this data of determining the position of obstacle the robot can move through the vacant space accordingly [6]. Swarm robots along with different level of system communication can be integrated for effective communication amongst the group of robots [7]. Since an autonomous robot can act out of order under unsolicited conditions. Manual controlled robots using Bluetooth and Near Field Communication (NFC) can be used [8]. Along with that through the easy of Android Device [8].

Encoder and Sensor Data are cross examined for the implementation of sensor fusion [9]. Due to multiple checks, there is an exponential dip in the probability of an error committed by a robot [9]. Twelve sonar sensors mounted in a circular manner to not miss any part of wall [10]. While following even while taking turn which appears use full at straight lines by distort the edges by making a circular or ellipse shape of a wall [10].

### 3. PROPOSED MODEL

#### 3.1 Mechanics of The Robot

The Robot uses a TWDD (Two-wheel differential drive with castor wheel due to its high turning accuracy and less actuator requirements i.e., 2 motors and wheels. Shape of the robot is a corner rounded square so for effective cleaning reach at corners of room.

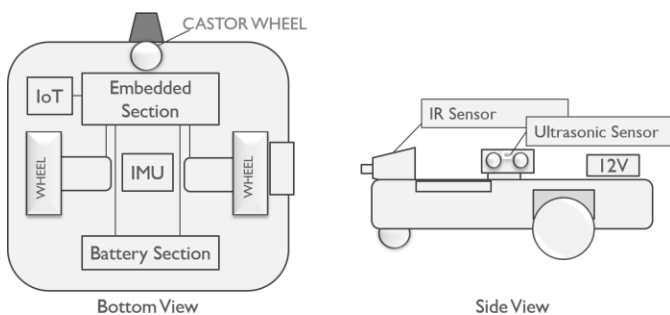

Fig – 3.1: Mechanical model

#### 3.2 Sensors

The robot uses an ultrasonic distance sensor HC SR04 placed at the left and an IR proximity sensor at the front. Motors are connected to the encoder respectively which give the distance travelled by the robot. An MPU6050 Gyroscope +

Accelerometer which is placed at the center of rotation axis, provides accurate turning and rotation using Kalman filtering algorithm.

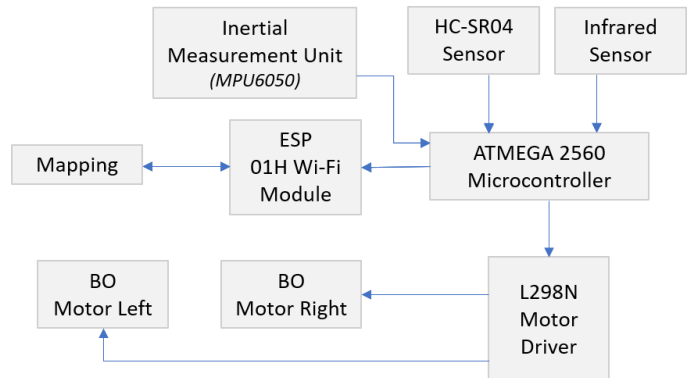

Fig – 3.2: Block diagram

### 4. PATH PLANNING ALGORITHMS

Unlike conventional robots which have rotating LIDARS mapping thousands of points every moment, our algorithm works in two phases:

1. Border map generation
2. Room navigation

The borders i.e., the walls of the rooms are mapped first so that it can know its limits after which the bot can navigate and clean the room.

#### 4.1 Border Map Generation

Considering fig 1.0 as a room layout, the robot is initially at a fixed start point initializing its spatial coordinates variable:  $(x, y) = (0, 0)$ .

The robot starts moving along the wall at its left maintaining a fixed distance from the wall this is done by a PID algorithm which inputs the distance between the wall then calculates the error which is the difference between the set point and the distance from the wall and outputs value which sets the strength and direction of turning distance maintain with the wall. The borders of the room robot all the walls and objects of the room and returns to the start point. This is done by use of encoders which provides the distance travelled by the wheels. The location of the robots is updated continuously using this encoder data. The error is given by:

$$Error = Distance\ from\ wall - Set\ point$$

**Corner Points:** These are the points where the robot takes a turn. While following the wall at its Left, if the robot reaches a wall detected by its front IR sensor, it takes a 90° right turn. When the error tolerance i.e., maximum error is greater than set point + 5, it indicates that the wall has ended and hence indicating a left turn.

The border map is generated by the robot while following the walls of the room, using and processing the data acquired by the rotary encoders and the IMU sensors. A directional vector is updated every time a turn is taken and the position is updated every moment. Using this vector, the robot's coordinates are updated on every iteration. The border map

is stored in the memory. Instead of storing every coordinate of the wall surface in a 2d array, only the X and Y coordinates of corner points are stored in a linear 1-D array assuming the wall being straight. This approximation was done because most of the houses have straight walls. In Fig 1.1 points from A to D, are the stored points. After mapping all the boundaries of the area, it reaches the start point.

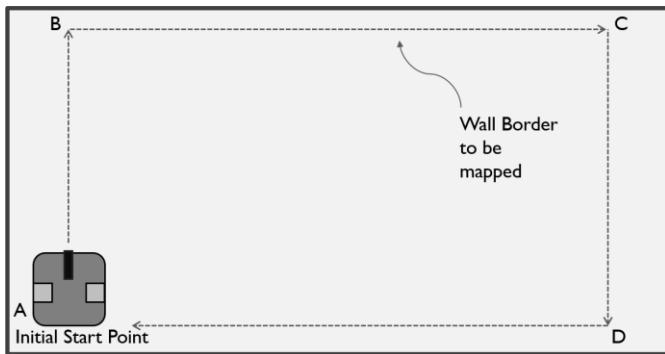

Fig - 4.1: Border Mapping

#### 4.2 Room Navigation

Robot after coming back to the start point starts navigating the room. It starts moving forward until any front obstacle encountered. When an obstacle appears, it takes a 90° turn, walks for a distance  $d$  and then again takes a 90° turn making a whole 180° U - turn. It travels in a zigzag alternating manner as in Fig 1.2, alternating between the Y-axis limits of the walls and incrementing X- axis by a fixed distance  $d$  which is the breadth of the robot. Alternate left and right turns are executed. The stored border map is stored in the array is read from the memory. The border points stored in the linear array are now the checkpoints which help the system to compare its location with respect to the checkpoints. The robot has to reach the  $n$  checkpoints one by one from A to D. It continuously keeps track of its position  $P = (x, y)$  and compares it with next checkpoint. As it reaches close to the checkpoint, it makes a check using the ultrasonic sensors and confirms whether it is a 'concave' or 'convex' checkpoint.

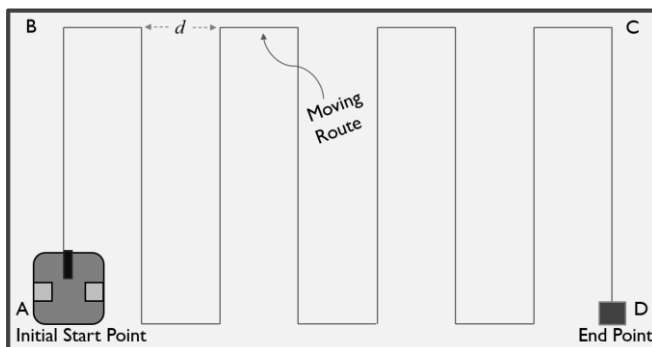

Fig -4.2: Room navigation alternating path

The robot alternates between two Y- Limits, lower limit and the upper limit. The initial coordinate  $CP$  which has the value of  $A$  is the lower Y-limit and the next  $(CP+1)$  point which is  $B$  is the upper Y-limit. Now after reaching the  $(CP+2)$  point, the  $CP$  is incremented and then a new upper limit and lower limit is set. In this way all the area is cleaned

After completing all the checkpoints, it arrives at the end point and then finds a way to reach the start point in the shortest path.

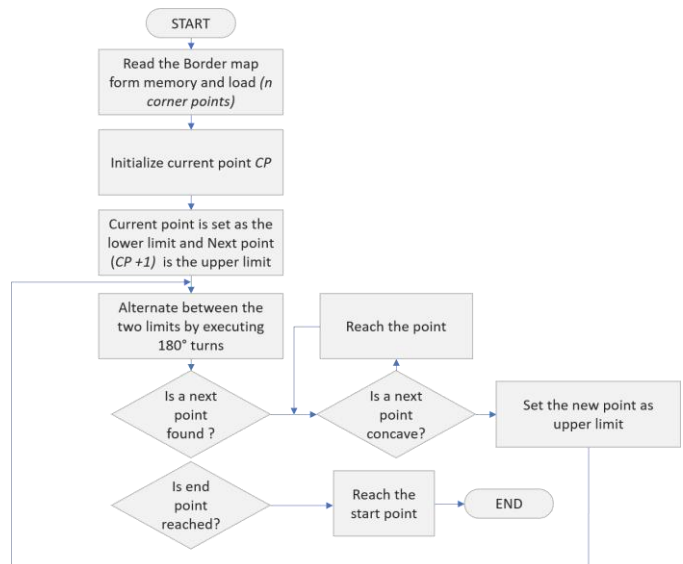

Fig - 4.1: Room navigation Algorithm

#### 5. ERROR CONTROLLING TECHNIQUES:

This particular application required correction methods implementation for alignment of motors while Wall-following to maintain a constant distance of robot with respect to the wall (PID).

Kalman Filter is implemented for an exact 90 degree turn while room navigation.

#### 5. WIRELESS COMMUNICATION AND MAPPING

An ESP-01 H based Wi-Fi Module is used to interface the robot with a JAVA based remote Mobile/Computer application which was developed using the Processing IDE. It communicates with Microcontroller via UART protocol and the wireless communication protocol for sending location coordinate data packets used was UDP due to its fast transmission rate.

Bot's Live location coordinates are sent to through the Microcontroller to Wi-Fi module to Remote device. The Map and live robot's location can be seen in the computer.

#### 6. VACUUM CLEANING SYSTEM

There are three sections involved in a vacuum cleaner:

- Motor, for turning the suction fan
- A powerful suction, fan capable of delivering 5 psi
- A filter, to trap the contaminants and dust.

As the vacuum cleaning part has to fit in our Robotic vacuum cleaner (RVC) in minimal space, a modification in the above design was to be made. So, the whole mechanism was converted and adjusted to fit in a small rectangular box. The inlet is a small rectangular opening at the bottom for the target dust to enter. The filter is placed at the opening section where the suction fan is present. The filters prevent

the dust from going into the suction fan and holds everything there. Most of the dust is blocked at the filter and falls down at the area in front of the filter and gets collected over there. The whole assembly requires only 12cm, 7cm, 5cm of space. Orthographic drawing is shown below with top view and side view.

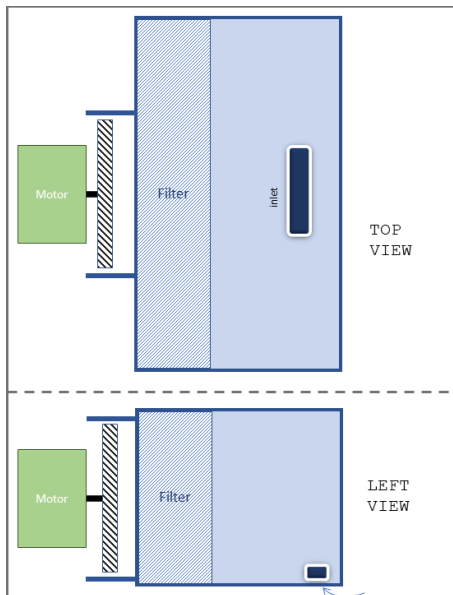

Fig -6.1: Vacuum cleaner section



Fig -7.2: Robot while border following and mapping

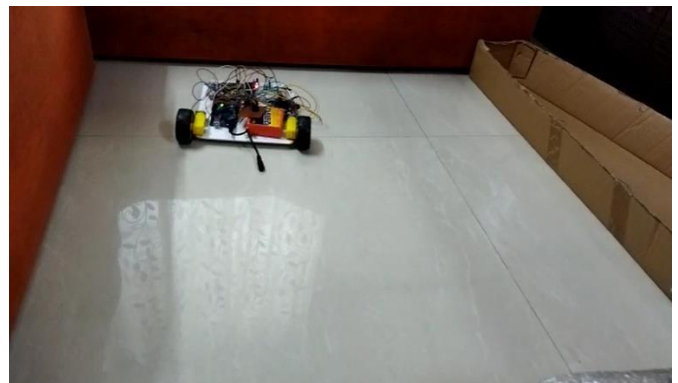

Fig -7.2: Robot while navigating

**CONCLUSIONS**

The map formed can be seen in Fig. 9.3. A remote laptop connected to internet is used to access the data sent by the robot's Wi-Fi Module. Area of 8.1 sq. meter to be explored and cleaned

Energy Consumed: The robot runs at 12 v for 2hrs at 1A average hence power would be

$$P = V \times I = 12 \times 1 = 12W$$



Fig -7.3: Robot monitoring on Remote pc wirelessly

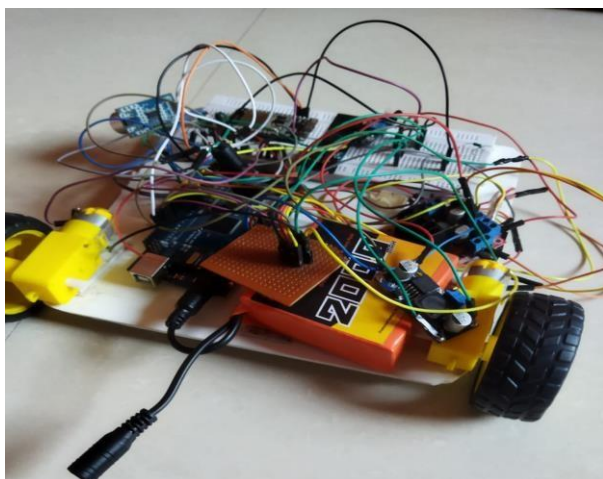

Fig -7: Robot assembly

**Table -1: Results**

Name of measurement	Value
Dimensions of given arena	0.9 m x 0.9 m.
Time Taken for border mapping	24 seconds
Initial start point error	2 cm

Maximum distance from wall	10 cm
Average distance from wall	9 cm
Power Consumption	2W
Navigation Time	1 min 10 seconds
Turning error	2°
Energy consumption	Spacing

Professor, Ambalika Institute of Management Technology, Lucknow, India [assocdean1@ambalika.co.in](mailto:assocdean1@ambalika.co.in) Dr. Raj Gaurang Tiwari Assistant Professor, Shri Ramswaroop Memorial College of Engineering and Management, Lucknow, India [rajgaurang@gmail.com](mailto:rajgaurang@gmail.com)

[10] Following a Wall by an Autonomous Mobile Robot with a Sonar-Ring Yoshinobu ANDO and Shin'ichi YUTA

## REFERENCES

[1] Mobile Robots Navigation in Indoor Environments Using Kinect Sensor. 2012 Second Brazilian Conference on Critical Embedded Systems.

[2] Eom, H. D., & Jeon, J. W. (2014). Environment map building using low-cost IR sensors and a servo motor for mobile robot. [3] Yata, T., Ohya, A., & Yuta, S. (n.d.). Fusion of omni-directional sonar and omni-directional vision for environment recognition of mobile robots. Proceedings 2000 ICRA. Millennium Conference. IEEE International Conference on Robotics and Automation. Symposia Proceedings (Cat. No.00CH37065). doi:10.1109/robot.2000.845343

[4] Research on logistics autonomous mobile robotsystem. 2016 IEEE International Conference on Mechatronics and Automation

[5] Energy Comparison of Controllers Used for a Differential Drive Wheeled Mobile Robot ALEXANDR STEFEK 1, VAN THUAN PHAM 1, VACLAV KRIVANEK2, KHAC LAM PHAM3

[6] Control a mobile robot in Social environments by considering human as a moving obstacle. 2018 6th RSI International Conference on Robotics and Mechatronics (IcRoM). doi:10.1109/icrom.2018.8657641

[7] Functional distribution among multiple mobile robots in an autonomous and decentralized robot system. Proceedings. 1991 IEEE International Conference on Robotics and Automation

[8] Design of Small Mobile Robot Remotely Controlled by an Android Operating System via Bluetooth and NFC Communication Kyung-Rok Kim1 , Seok-Hwan Jeong1 , Woo-Yong Kim1 , Youngjun Jeon1 , Kyung-Soo Kim1 and Je-Hoon Hong2

[9] Exploiting Sensor Fusion for Mobile Robot Localization Harshita Agarwal M. Tech Scholar, Dr. Abdul Kalam Technical University, Lucknow, India [harshi2293@gmail.com](mailto:harshi2293@gmail.com) Dr. Pankaj Tiwari Associate