

# THREE DIMENSIONAL STUDIES ON FLOW DISTRIBUTIONS IN SAVONIOUS ROTORS

P. Venkateswara Rao

Associate Professor, Department of Mechanical Engineering,  
Vasavi College of Engineering, Ibrahimbagh, Hyderabad – 500 031.

\*\*\*

**ABSTRACT:** Savonious rotors continue to interest research investigators in view of its many advantageous features. The simple design of the rotor enables the achievement of a low cost and compact wind power device, although its efficiency may not be comparable with other vertical axis machines such as Darraeus rotor. In wind deficient zones, one can adapt these rotors with success. Different configurations of the Savonious rotor have been proposed to overcome some of the limitations of the earlier Savonious rotors, which have very low tip speed ratios. Design guidelines have been enunciated for the design of the rotors, based on experience with field-installed rotors. Although a few CFD investigations have been reported on the flow analysis of Savonious rotors earlier, there appears to be no serious attempt made earlier for a three-dimensional analysis of flow distribution in these rotors to enable a more realistic understanding of the rotor behavior. In the present paper an attempt is made to carry out a detailed three-dimensional CFD analysis of the basic configuration of the Savonious rotor. A parametric analysis is carried out to understand the performance of the rotor. Comparisons have been made between the results obtained from the three-dimensional analyses with those from two-dimensional analysis by the authors and reported elsewhere. The commercially available Fluent version 6.1.2 has been used extensively in the present analysis.

**Keywords:** Savonious rotor, CFD analysis, wind energy, twin rotor.

## 1. INTRODUCTION

In the present-day philosophy for the design of fluid machinery, flow visualization and flow analysis have become an integral part. With the availability of computer simulation software for computational fluid dynamics, many problems, which are difficult to solve, have become tractable to solve. Savonious wind rotors can produce energy from wind power for the purpose of water pumping [1] and electricity [2] at low wind speeds. Although the efficiency is very low, high starting torque and large simplicity in its construction (Fig. 1a&b) and operation have enabled researchers to expend efforts at continual improvement of Savonious rotors.

The disadvantages include difficulty of designing for high wind speeds. Although many earlier investigators [3–6] have reported on the design, development and testing of Savonious rotor, very few investigators have reported a detailed three-dimensional CFD analysis of these rotors.

Cochran et al [7] have discussed a three-pronged approach for the design including CFD analyses and wind tunnel testing. Rahai et al [8] have reported a method for aerodynamic optimization to improve the torques in split Savonious rotors. In the present paper, an extensive three-dimensional CFD analysis of a practical configuration of Savonious rotor is carried out. The theoretical results from the analysis have been correlated either with those from wind tunnel tests by earlier investigators or with reported test data on actual rotors in site conditions.

## 2. DESIGN OF SAVONIOUS ROTORS:

Based on the work of earlier researchers, the following design guidelines have been documented in the previous publications and are given below.

(1) The size of the end plates, to which are mounted the bucket, should be about 5% larger than the diameter of the rotor. (2) The central shaft should be mounted to the end plates only, and not through the buckets. By keeping the shaft to the end plates, the air space is not blocked.

For example, a central shaft of about 20% of the rotor diameter reduces the power coefficient by about 8%. (3) The aspect ratio, height to diameter; 6 to 8 gives a better performance. However, an aspect ratio of about 2 is desirable from the economic point of view. (4) Use only two buckets as higher number reduces the efficiency. (5) Use of augmentation devices such as concentrator or diffuser or a combination of the two results in increased power coefficient. Again, the increased costs of such devices should be weighted against the increased capital cost and complexities.

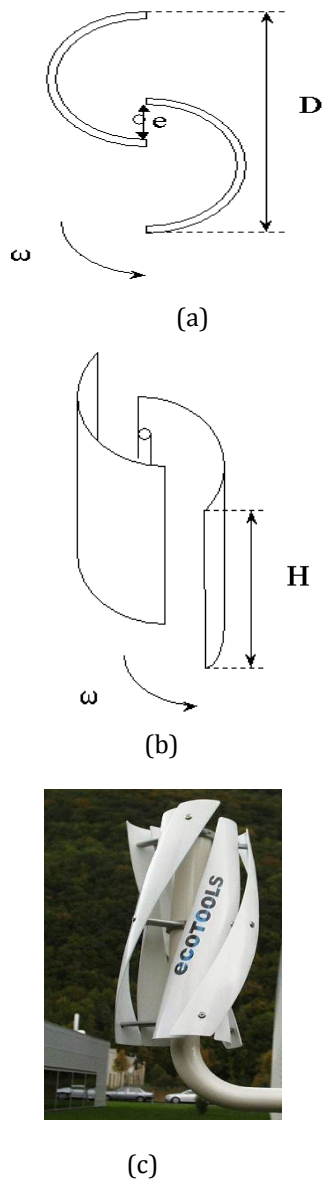

Fig.1. Configurations of Savonius Rotor

### 3. MODELING OF SAVONIOUS ROTOR AND ITS ANALYSIS

A three-dimensional analysis of the Savonius rotor having two 0.4m-diameter vanes and without vane offset ( $e=0$  in Fig 1a) is carried out using the computational fluid dynamics approach. The need for carrying out a three-dimensional analysis as an extension to the earlier two-dimensional analyses of the present and other authors is to understand the fluid flow aspects near the end closures of the vanes of the rotor (Fig 1a) in addition to flow behavior

inside the vanes and in the near vicinity of the rotor. The wind is assumed to comprise of pure air under standard conditions of temperature of 20 °C, density of 1.19 N/m<sup>3</sup>. The velocity regime considered in the present work is 6 m/s, which value is imposed as a boundary condition, in a direction normal to the axis of the rotor.

Gambit software is used as the pre-processor for constructing the geometry, mesh building and assigning the boundary zones on the geometry of the Savonius rotor. A three-dimensional geometry is used for simulation, with area of interest as a circular boundary of radius, 1.5 m. The blades of the Savonius rotor are taken as a semi-circular shape with radius 0.2 m with no offset. Here two vanes are used on the rotor, which are placed adjacent to each other but facing in opposite direction. The domain is meshed with tetrahedral elements and the critical region is densely meshed. The velocity inlet and pressure outlet boundary zones are assigned, and the model is exported to fluent, which is used for solving and post processing. A segregated 3D implicit model is used and the fluid, air, properties are assigned. The governing conservation of mass, momentum and turbulent equations are discretized using second order upwind scheme and pressure velocity coupling equation is represented with SIMPLE algorithm. Fig.2. shows the typical configuration and the mesh of the rotor without vane offset. An earlier investigation has revealed that the k-ε model is the preferred model for simulating turbulence and the same has been used in the present analysis. Appropriate convergence criteria have been utilized to check the results.

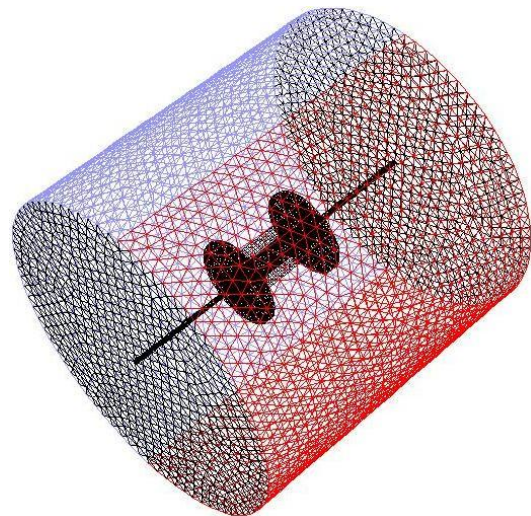

Fig.2. Mesh for Savonius Rotor without eccentricity

#### 4. RESULTS AND DISCUSSION

The velocity and static pressure distributions at the mid-plane of the rotor are given in Fig.3.

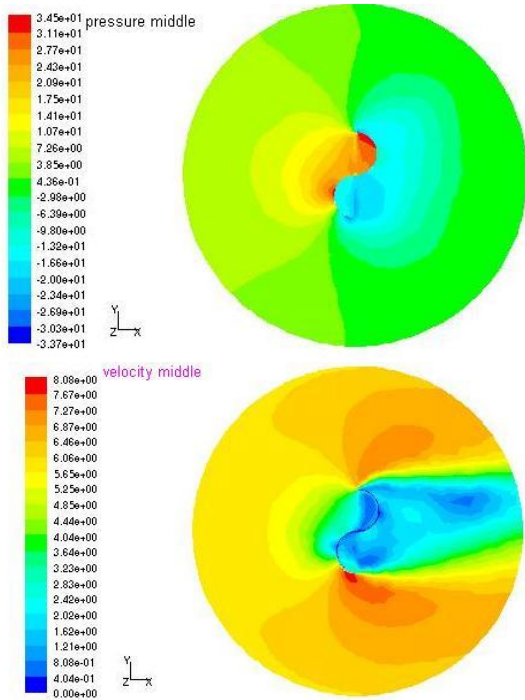

Fig.3. Three- dimensional analysis of the Savonius rotor - Results for the mid-plane of the rotor.

Fig.4 shows the sections on the Savonius rotor at which results for the velocity and pressure distributions are discussed.

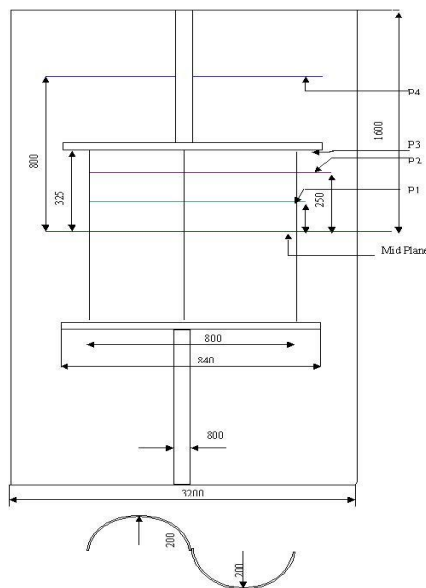

Fig.4. Location of Sections on Savonius Rotor for discussing the results

The contours for velocity and static pressure in planes perpendicular to the vanes at locations of the rotor as per the scheme in Fig. 4 are shown in Figs. 5 and 6 respectively. It can be observed from these contour maps that they exhibit an excellent symmetry of the results about the mid plane of the rotor.

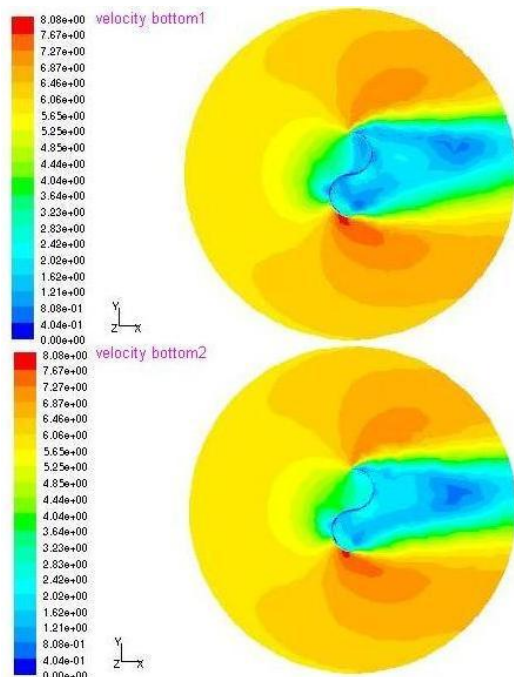
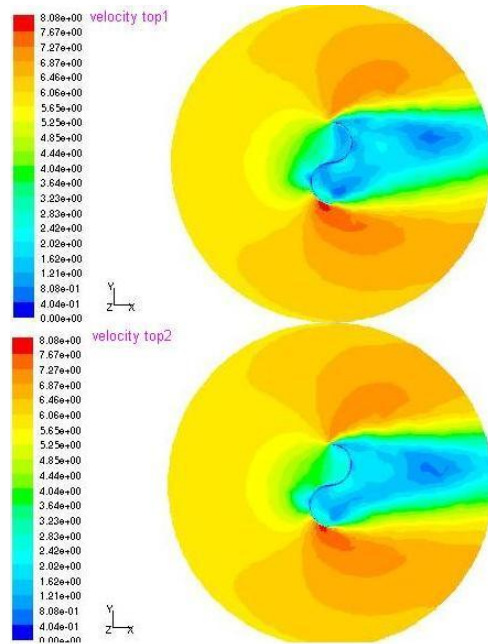

Fig.5. Contours of velocity at cross-sections 1 to 4.

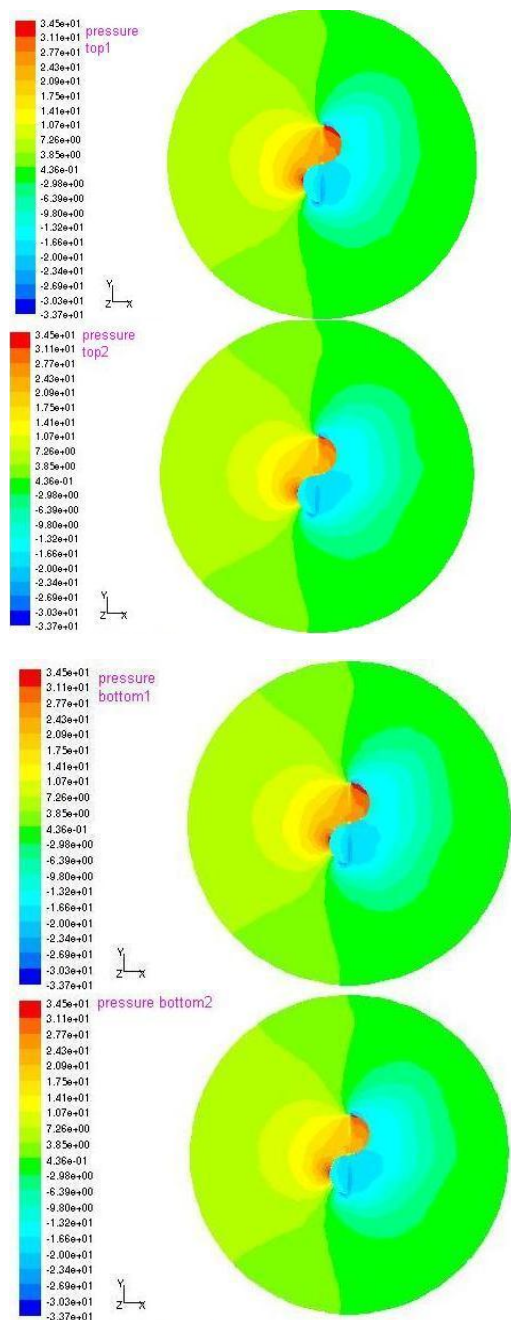

Fig.6. Contours of pressure at cross-sections 1 to 4.

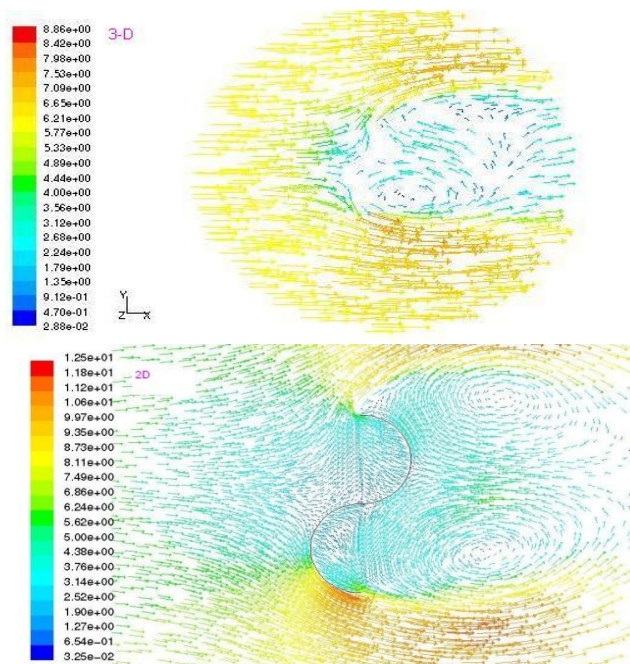

Fig.7. Comparison of the velocities at the mid-plane

The velocities are better understood by observing a plot of velocity vectors as shown in Fig. 7. It can be observed that the 2D analysis yields a value of around 2.42 m/s while the 3D analysis gives a value of 2.49 m/s at the inlet vane.

### 5. CONCLUSION

A three-dimensional analysis of Savonius rotor has been carried out in the present analysis. The results obtained are compared with those from the 2D analysis of the earlier investigators and the deviations in the velocities and pressures have been highlighted.

### REFERENCES

- [1]. F. Gardelle, 2000; "etude experimentale d'une eolienne savonius en soufflerie atmosferique Manuel d'utilisation de PIVIS". IMFT Service Signaux et Images du departement electrotechnique de l'ENSEEIH, France.
- [2]. Mganilwa, Z. M, "Development of a Savonius Wind Turbine Water Pumping System, Technical Report of the Department of Mechanical Engineering", Dar es Salaam Institute of Technology, Tanzania.
- [3]. N. Fujisawa, F. Gotoh 1992; "Visualization study of the flow in and around a Savonius rotor". Experiments in Fluids 12 pp 407~412

- 
- [4]. M.A. Kotb, T.K. Aldoss 1991; "Flow field around a partially-blocked Savonius rotor". Applied Energy 38 pp 117~132
- [5]. N. Fujisawa, K. Ishimatsu, K. Kage 1995; "A comparative study of Navier-Stokes calculations and experiments for the Savonius Rotor". Journal of Solar Energy Engineering 117 pp 344~346
- [6]. D. BENGHRIB, A. AHAM, L. BACHIR 1998 ; "Description de l'alternance des tourbillons d'un rotor Savonius par visualisation en tunel hydrodynamique". Compte Rendu de l'Académie des Sciences, Tome 326, Série II, pp 495~500
- [7]. Cochran. B.C., D. Banks and S.J. Taylor, "A three-tiered approach for designing and evaluating performance characteristics of novel wecs". AIAA-2004-1362.
- [8]. Rahai.R. Hamid, Hefaiz Hamid, "Energy innovations small grant (EISG) program", grant#: 00-17
- [9]. N. Fujisawa 1995; "Velocity measurements and numerical 2calculations of flow fields in and around Savonius rotors". Journal of Wind Engineering and Industrial Aerodynamics 59 pp 39~50
- [10]. V.J. Modi, M.S.U.K Fernando 1989; "On the Performance of the Savonius Wind Turbine". Journal of Solar Energy Engineering 111 pp 71~81
- [11]. Job S. Ebenezer, Savonius windmill, Report of the Department of Messiah College, Grantham, PA 17027
- [12]. Fluent user's manual